

Modern Orthodontics

ORTHODONTIC PRODUCTS CATALOG

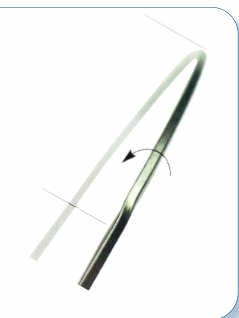

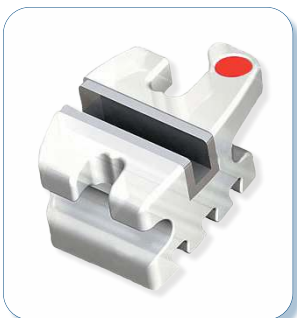
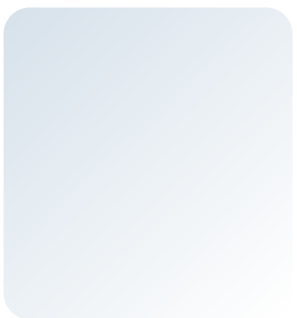
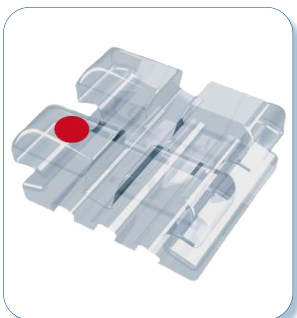

Metal Injection Moulding (MIM) using German Machines

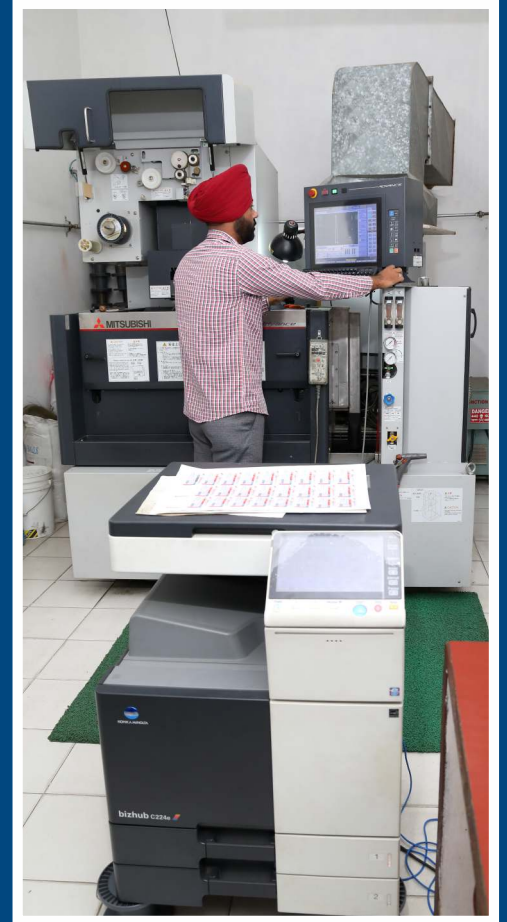

In-house EDM Wire cut Made in Japan

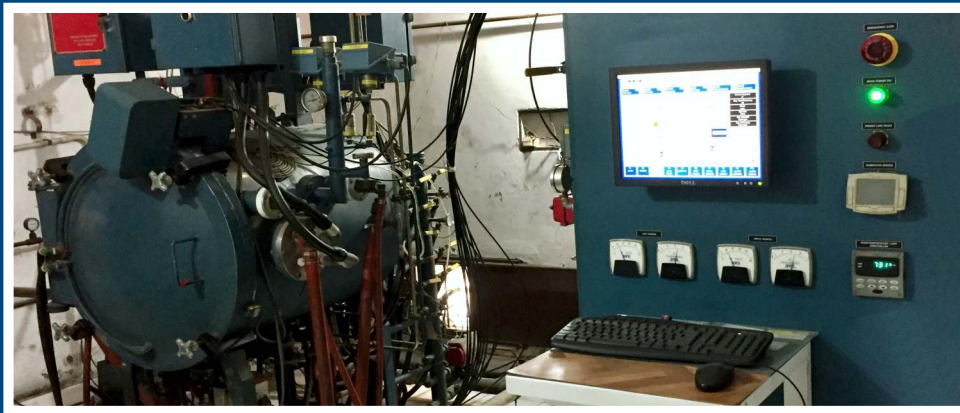

Vacuum Sintering Furnace made in USA











Quality Inspection Welding Section

Made with pride in INDIA
Made for the WORLD



Index

Aesthetic Brackets	(1-10)	
Metal Brackets	(11-19)	
Molar Tubes	(20-24)	
Molar Bands	(25-28)	
Nitinol Wires	(29-38)	
Stainless Steel Wires	(39-40)	
Posted Wires	(41)	
Ligature Wires	(42)	
Co-Axial Wires	(43)	
Beta Titanium Wires	(44)	
Coated Wires	(45)	
Archwire Shapes	(46)	
Elastomerics	(47)	
Adhesives	(48)	
Extra Oral Appliances	(48)	
Miscellaneous Supplies	(49)	
Instruments	(50-56)	

Totally Invisible Zero Glare Surface

We know that excessive diamond like glare can make a clear bracket more visible

Ultra-Smooth, Strong Hooks

For added patient comfort and secure engagement of elastics

Smooth, Strong and Contoured Tie Wings

For added patient comfort

Removable Color Coded ID Dot

For easy bracket selection

Archwire Slot Design

Diamond and heat polished for superior sliding mechanics

Ample Tie Wing Area

For easy wire ligation

Ultra Smooth Slot

Offers 45% less friction compared to saw-cut style Mono-Sapphire

Compound Contour Base

Provides simplified and accurate bracket placement

Mechanical Bonding Base

Provides superior mechanical bond strength and predictable debonding

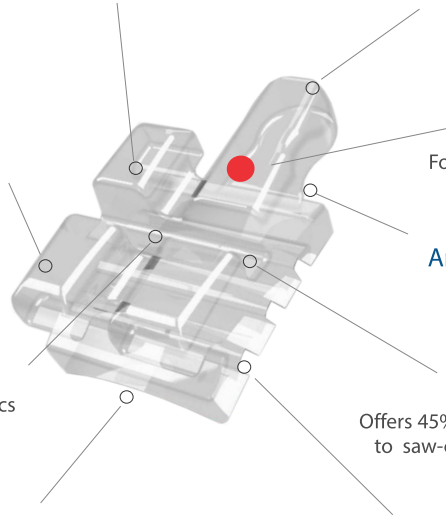

➤ **Double Fracture Toughness**

➤ **Less Shatter on de-bonding**

➤ **Zero Glare Surface**

➤ **Ultra Smooth Slot**

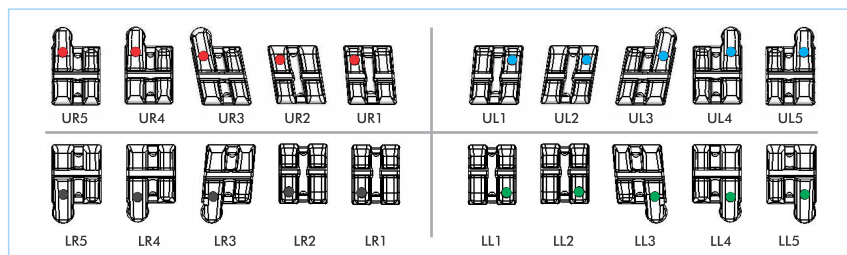
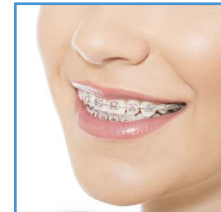



Roth Prescription

Maxillary ▲

Tooth	Torque	Angle	Width	R/L	ID	.018	.022
$\frac{1}{1}$ Central	+12°	+5°	.125"	R	●	BTC-R8-001	BTC-R2-001
				L	●	BTC-R8-002	BTC-R2-002
$\frac{2}{2}$ Lateral	+8°	+9°	.122"	R	●	BTC-R8-003	BTC-R2-003
				L	●	BTC-R8-004	BTC-R2-004
$\frac{3}{3}$ Cuspid with Hook	0°	+11°	.122"	R	●	BTC-R8-005	BTC-R2-005
				L	●	BTC-R8-006	BTC-R2-006
$\frac{4}{5}$ / $\frac{4}{5}$ 1 st & 2 nd Bicuspid	-7°	0°	.122"	R	●	BTC-R8-009	BTC-R2-009
				L	●	BTC-R8-010	BTC-R2-010
$\frac{4}{5}$ / $\frac{4}{5}$ 1 st & 2 nd Bicuspid Hk	-7°	0°	.122"	R	●	BTC-R8-011	BTC-R2-011
				L	●	BTC-R8-012	BTC-R2-012

MBT Prescription

Maxillary ▲

Tooth	Torque	Angle	Width	R/L	ID	.018	.022
$\frac{1}{1}$ Central	+17°	+4°	.125"	R	●	BTC-M8-101	BTC-M2-101
				L	●	BTC-M8-102	BTC-M2-102
$\frac{2}{2}$ Lateral	+10°	+8°	.122"	R	●	BTC-M8-103	BTC-M2-103
				L	●	BTC-M8-104	BTC-M2-104
$\frac{3}{3}$ Cuspid with hook	0°	+9°	.122"	R	●	BTC-M8-105	BTC-M2-105
				L	●	BTC-M8-106	BTC-M2-106
$\frac{3}{3}$ Cuspid with hook	-7°	+9°	.122"	R	●	BTC-M8-107	BTC-M2-107
				L	●	BTC-M8-108	BTC-M2-108
$\frac{4}{5}$ / $\frac{4}{5}$ 1 st & 2 nd Bicuspid	-7°	0°	.122"	R	●	BTC-M8-109	BTC-M2-109
				L	●	BTC-M8-110	BTC-M2-110
$\frac{4}{5}$ / $\frac{4}{5}$ 1 st & 2 nd Bicuspid Hk	-7°	0°	.122"	R	●	BTC-M8-111	BTC-M2-111
				L	●	BTC-M8-112	BTC-M2-112

Roth Prescription

Mandibular ▼

Tooth	Torque	Angle	Width	R/L	ID	.018	.022
$\frac{1}{2}$ / $\frac{1}{2}$ Lower Anterior	0°	0°	.116"	R	●	BTC-R8-014	BTC-R2-014
				L	●	BTC-R8-015	BTC-R2-015
$\frac{3}{3}$ Cuspid With hook	-11°	+5°	.122"	R	●	BTC-R8-016	BTC-R2-016
				L	●	BTC-R8-017	BTC-R2-017
$\frac{4}{4}$ 1 st Bicuspid	-17°	0°	.122"	R	●	BTC-R8-020	BTC-R2-020
				L	●	BTC-R8-021	BTC-R2-021
$\frac{4}{4}$ 1 st Bicuspid with hook	-17°	0°	.122"	R	●	BTC-R8-022	BTC-R2-022
				L	●	BTC-R8-023	BTC-R2-023
$\frac{5}{5}$ 2 nd Bicuspid	-22°	0°	.122"	R	●	BTC-R8-024	BTC-R2-024
				L	●	BTC-R8-025	BTC-R2-025
$\frac{5}{5}$ 2 nd Bicuspid with hook	-22°	0°	.122"	R	●	BTC-R8-026	BTC-R2-026
				L	●	BTC-R8-027	BTC-R2-027

MBT Prescription

Mandibular ▼

Tooth	Torque	Angle	Width	R/L	ID	.018	.022
$\frac{1}{2}$ / $\frac{1}{2}$ Lower Anterior	-6°	0°	.116"	R	●	BTC-M8-114	BTC-M2-114
				L	●	BTC-M8-115	BTC-M2-115
$\frac{3}{3}$ Cuspid with hook	0°	+3°	.122"	R	●	BTC-M8-116	BTC-M2-116
				L	●	BTC-M8-117	BTC-M2-117
$\frac{3}{3}$ Cuspid with hook	-6°	+3°	.122"	R	●	BTC-M8-118	BTC-M2-118
				L	●	BTC-M8-119	BTC-M2-119
$\frac{4}{4}$ 1 st Bicuspid	-12°	+2°	.122"	R	●	BTC-M8-120	BTC-M2-120
				L	●	BTC-M8-121	BTC-M2-121
$\frac{4}{4}$ 1 st Bicuspid with hook	-12°	+2°	.122"	R	●	BTC-M8-122	BTC-M2-122
				L	●	BTC-M8-123	BTC-M2-123
$\frac{5}{5}$ 2 nd Bicuspid	-17°	+2°	.122"	R	●	BTC-M8-124	BTC-M2-124
				L	●	BTC-M8-125	BTC-M2-125
$\frac{5}{5}$ 2 nd Bicuspid with hook	-17°	+2°	.122"	R	●	BTC-M8-126	BTC-M2-126
				L	●	BTC-M8-127	BTC-M2-127

Full Kits ▲▼

Kits	.018	.022
Upper/Lower 5x5 Hook on 3	BKC-R8-102	BKC-R2-102
Upper/Lower 5x5 Hooks on 3,4 & 5	BKC-R8-104	BKC-R2-104

Full Kits ▲▼

Kits	.018	.022
Upper/Lower 5x5 Hook on 3	BKC-M8-102*	BKC-M2-102*
Upper/Lower 5x5 Hooks on 3,4 & 5	BKC-M8-104*	BKC-M2-104*
Upper/Lower 5x5 Hook on 3	BKC-M8-202	BKC-M2-202
Upper/Lower 5x5 Hooks on 3,4 & 5	BKC-M8-204	BKC-M2-204

* Cuspid brackets in these Kits are having 0 deg torque in uppers and -6 deg torque in lowers.

Other kits have -7 deg torque in uppers and -6 deg torque in lowers.

For any other cuspid torque combination, please place order for individual brackets.



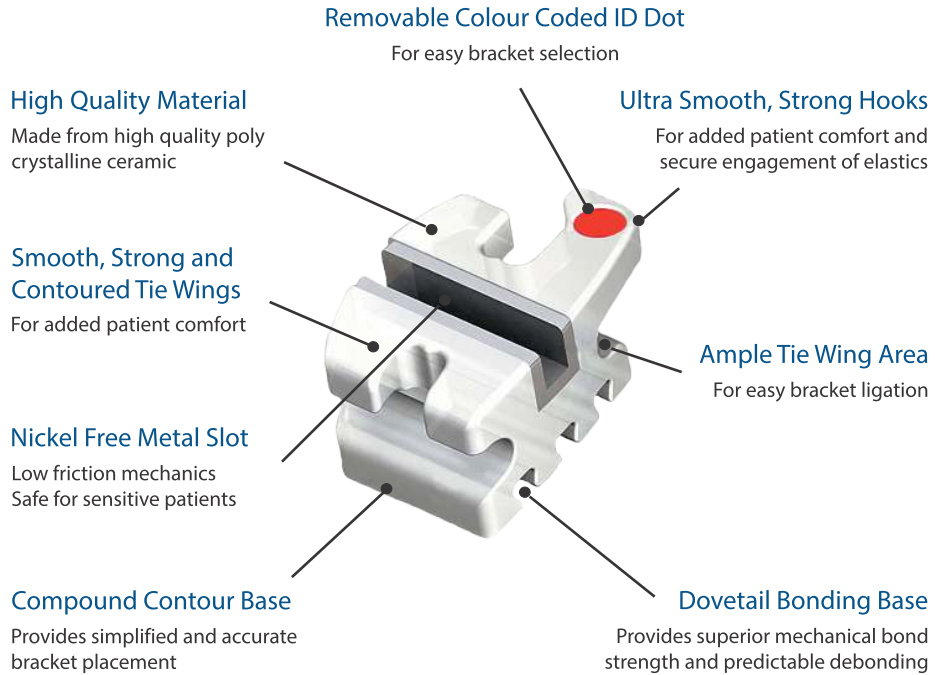

➔ **Non Allergic Metal Slot**

➔ **Ultra Smooth Slot**

➔ **Pure Mechanical Bonding**

➔ **99.99% Pure Alumina**



Compare to
Clarity™ by 3M Unitek
Encore™ by Ortho Technology

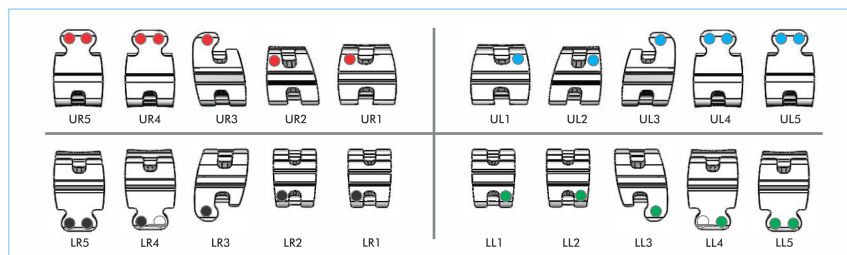



Roth Prescription

Maxillary ▲

Tooth	Torque	Angle	Width	R/L	ID	.018	.022
$\frac{1}{1}$ Central	+12°	+5°	.155"	R	●	BTP-R8-301	BTP-R2-301
				L	●	BTP-R8-302	BTP-R2-302
$\frac{2}{2}$ Lateral	+8°	+9°	.133"	R	●	BTP-R8-303	BTP-R2-303
				L	●	BTP-R8-304	BTP-R2-304
$\frac{3}{3}$ Cuspid with Hook	0°	+11°	.131"	R	●	BTP-R8-305	BTP-R2-305
				L	●	BTP-R8-306	BTP-R2-306
$\frac{4}{5}$ / $\frac{4}{5}$ 1 st & 2 nd Bicuspid	-7°	0°	.130"	R	●	BTP-R8-309	BTP-R2-309
				L	●	BTP-R8-310	BTP-R2-310
$\frac{4}{5}$ / $\frac{4}{5}$ 1 st & 2 nd Bicuspid Hk	-7°	0°	.130"	R	●	BTP-R8-311	BTP-R2-311
				L	●	BTP-R8-312	BTP-R2-312

MBT Prescription

Maxillary ▲

Tooth	Torque	Angle	Width	R/L	ID	.018	.022
$\frac{1}{1}$ Central	+17°	+4°	.125"	R	●	BTP-M8-301	BTP-M2-301
				L	●	BTP-M8-302	BTP-M2-302
$\frac{2}{2}$ Lateral	+10°	+8°	.122"	R	●	BTP-M8-303	BTP-M2-303
				L	●	BTP-M8-304	BTP-M2-304
$\frac{3}{3}$ Cuspid with hook	0°	+9°	.122"	R	●	BTP-M8-305	BTP-M2-305
				L	●	BTP-M8-306	BTP-M2-306
$\frac{3}{3}$ Cuspid with hook	-7°	+9°	.122"	R	●	BTP-M8-307	BTP-M2-307
				L	●	BTP-M8-308	BTP-M2-308
$\frac{4}{5}$ / $\frac{4}{5}$ 1 st & 2 nd Bicuspid	-7°	0°	.122"	R	●	BTP-M8-309	BTP-M2-309
				L	●	BTP-M8-310	BTP-M2-310
$\frac{4}{5}$ / $\frac{4}{5}$ 1 st & 2 nd Bicuspid Hk	-7°	0°	.122"	R	●	BTP-M8-311	BTP-M2-311
				L	●	BTP-M8-312	BTP-M2-312

Roth Prescription

Mandibular ▼

Tooth	Torque	Angle	Width	R/L	ID	.018	.022
$\frac{1}{2}$ / $\frac{1}{2}$ Lower Anterior	0°	0°	.110"	R	●	BTP-R8-314	BTP-R2-314
				L	●	BTP-R8-315	BTP-R2-315
$\frac{3}{3}$ Cuspid With hook	-11°	+5°	.133"	R	●	BTP-R8-316	BTP-R2-316
				L	●	BTP-R8-317	BTP-R2-317
$\frac{4}{4}$ 1 st Bicuspid	-17°	0°	.133"	R	●	BTP-R8-320	BTP-R2-320
				L	●	BTP-R8-321	BTP-R2-321
$\frac{4}{4}$ 1 st Bicuspid with hook	-17°	0°	.133"	R	●	BTP-R8-322	BTP-R2-322
				L	●	BTP-R8-323	BTP-R2-323
$\frac{5}{5}$ 2 nd Bicuspid	-22°	0°	.133"	R	●	BTP-R8-324	BTP-R2-324
				L	●	BTP-R8-325	BTP-R2-325
$\frac{5}{5}$ 2 nd Bicuspid with hook	-22°	0°	.133"	R	●	BTP-R8-326	BTP-R2-326
				L	●	BTP-R8-327	BTP-R2-327

MBT Prescription

Mandibular ▼

Tooth	Torque	Angle	Width	R/L	ID	.018	.022
$\frac{1}{2}$ / $\frac{1}{2}$ Lower Anterior	-6°	0°	.116"	R	●	BTP-M8-314	BTP-M2-314
				L	●	BTP-M8-315	BTP-M2-315
$\frac{3}{3}$ Cuspid with hook	0°	+3°	.122"	R	●	BTP-M8-316	BTP-M2-316
				L	●	BTP-M8-317	BTP-M2-317
$\frac{3}{3}$ Cuspid with hook	-6°	+3°	.122"	R	●	BTP-M8-318	BTP-M2-318
				L	●	BTP-M8-319	BTP-M2-319
$\frac{4}{4}$ 1 st Bicuspid	-12°	+2°	.122"	R	●	BTP-M8-320	BTP-M2-320
				L	●	BTP-M8-321	BTP-M2-321
$\frac{4}{4}$ 1 st Bicuspid with hook	-12°	+2°	.122"	R	●	BTP-M8-322	BTP-M2-322
				L	●	BTP-M8-323	BTP-M2-323
$\frac{5}{5}$ 2 nd Bicuspid	-17°	+2°	.122"	R	●	BTP-M8-324	BTP-M2-324
				L	●	BTP-M8-325	BTP-M2-325
$\frac{5}{5}$ 2 nd Bicuspid with hook	-17°	+2°	.122"	R	●	BTP-M8-326	BTP-M2-326
				L	●	BTP-M8-327	BTP-M2-327

Full Kits ▲▼

Kits	.018	.022
Upper/Lower 5x5 Hook on 3	BKP-R8-112	BKP-R2-112
Upper/Lower 5x5 Hooks on 3,4 & 5	BKP-R8-114	BKP-R2-114

Full Kits ▲▼

Kits	.018	.022
Upper/Lower 5x5 Hook on 3	BKP-M8-112*	BKP-M2-112*
Upper/Lower 5x5 Hooks on 3,4 & 5	BKP-M8-114*	BKP-M2-114*
Upper/Lower 5x5 Hook on 3	BKP-M8-212	BKP-M2-212
Upper/Lower 5x5 Hooks on 3,4 & 5	BKP-M8-214	BKP-M2-214

* Cuspid brackets in these Kits are having 0 deg torque in uppers and -6 deg torque in lowers.

Other kits have -7 deg torque in uppers and -6 deg torque in lowers.

For any other cuspid torque combination, please place order for individual brackets.



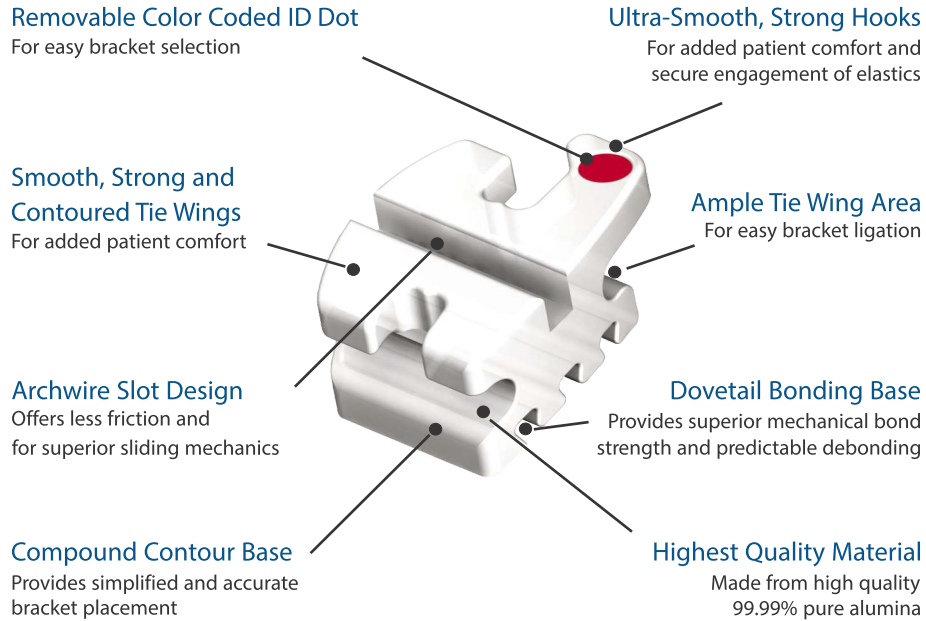

Compare to
 Illusion Plus™ by Ortho Organizers
 Eclipse™ by Masel, Reflections™ by Ortho Technology

Translucent | Micro Crack Free
Pure Mechanical Bonding | 99.99% Pure Alumina

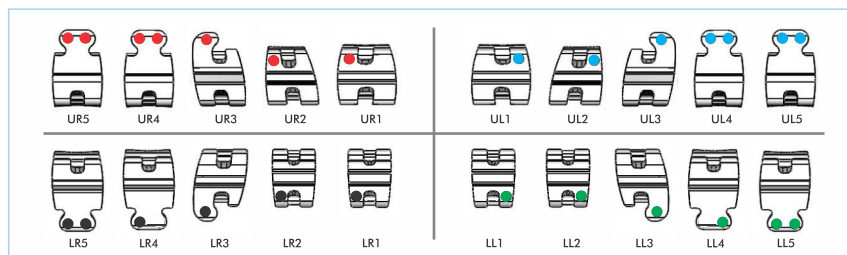



Roth Prescription

Maxillary ▲

Tooth	Torque	Angle	Width	R/L	ID	.018	.022
$\frac{1}{1}$ Central	+12°	+5°	.155"	R	●	BTP-R8-001	BTP-R2-001
				L	●	BTP-R8-002	BTP-R2-002
$\frac{2}{2}$ Lateral	+8°	+9°	.133"	R	●	BTP-R8-003	BTP-R2-003
				L	●	BTP-R8-004	BTP-R2-004
$\frac{3}{3}$ Cuspid with Hook	0°	+11°	.131"	R	●	BTP-R8-005	BTP-R2-005
				L	●	BTP-R8-006	BTP-R2-006
$\frac{4}{5}$ / $\frac{4}{5}$ 1 st & 2 nd Bicuspid	-7°	0°	.130"	R	●	BTP-R8-009	BTP-R2-009
				L	●	BTP-R8-010	BTP-R2-010
$\frac{4}{5}$ / $\frac{4}{5}$ 1 st & 2 nd Bicuspid Hk	-7°	0°	.130"	R	●	BTP-R8-011	BTP-R2-011
				L	●	BTP-R8-012	BTP-R2-012

MBT Prescription

Maxillary ▲

Tooth	Torque	Angle	Width	R/L	ID	.018	.022
$\frac{1}{1}$ Central	+17°	+4°	.125"	R	●	BTP-M8-101	BTP-M2-101
				L	●	BTP-M8-102	BTP-M2-102
$\frac{2}{2}$ Lateral	+10°	+8°	.122"	R	●	BTP-M8-103	BTP-M2-103
				L	●	BTP-M8-104	BTP-M2-104
$\frac{3}{3}$ Cuspid with hook	0°	+9°	.122"	R	●	BTP-M8-105	BTP-M2-105
				L	●	BTP-M8-106	BTP-M2-106
$\frac{3}{3}$ Cuspid with hook	-7°	+9°	.122"	R	●	BTP-M8-107	BTP-M2-107
				L	●	BTP-M8-108	BTP-M2-108
$\frac{4}{5}$ / $\frac{4}{5}$ 1 st & 2 nd Bicuspid	-7°	0°	.122"	R	●	BTP-M8-109	BTP-M2-109
				L	●	BTP-M8-110	BTP-M2-110
$\frac{4}{5}$ / $\frac{4}{5}$ 1 st & 2 nd Bicuspid Hk	-7°	0°	.122"	R	●	BTP-M8-111	BTP-M2-111
				L	●	BTP-M8-112	BTP-M2-112

Roth Prescription

Mandibular ▼

Tooth	Torque	Angle	Width	R/L	ID	.018	.022
$\frac{1}{2}$ / $\frac{1}{2}$ Lower Anterior	0°	0°	.110"	R	●	BTP-R8-014	BTP-R2-014
				L	●	BTP-R8-015	BTP-R2-015
$\frac{3}{3}$ Cuspid With hook	-11°	+5°	.133"	R	●	BTP-R8-016	BTP-R2-016
				L	●	BTP-R8-017	BTP-R2-017
$\frac{4}{4}$ 1 st Bicuspid	-17°	0°	.133"	R	●	BTP-R8-020	BTP-R2-020
				L	●	BTP-R8-021	BTP-R2-021
$\frac{4}{4}$ 1 st Bicuspid with hook	-17°	0°	.133"	R	●	BTP-R8-022	BTP-R2-022
				L	●	BTP-R8-023	BTP-R2-023
$\frac{5}{5}$ 2 nd Bicuspid	-22°	0°	.133"	R	●	BTP-R8-024	BTP-R2-024
				L	●	BTP-R8-025	BTP-R2-025
$\frac{5}{5}$ 2 nd Bicuspid with hook	-22°	0°	.133"	R	●	BTP-R8-026	BTP-R2-026
				L	●	BTP-R8-027	BTP-R2-027

MBT Prescription

Mandibular ▼

Tooth	Torque	Angle	Width	R/L	ID	.018	.022
$\frac{1}{2}$ / $\frac{1}{2}$ Lower Anterior	-6°	0°	.116"	R	●	BTP-M8-114	BTP-M2-114
				L	●	BTP-M8-115	BTP-M2-115
$\frac{3}{3}$ Cuspid with hook	0°	+3°	.122"	R	●	BTP-M8-116	BTP-M2-116
				L	●	BTP-M8-117	BTP-M2-117
$\frac{3}{3}$ Cuspid with hook	-6°	+3°	.122"	R	●	BTP-M8-118	BTP-M2-118
				L	●	BTP-M8-119	BTP-M2-119
$\frac{4}{4}$ 1 st Bicuspid	-12°	+2°	.122"	R	●	BTP-M8-120	BTP-M2-120
				L	●	BTP-M8-121	BTP-M2-121
$\frac{4}{4}$ 1 st Bicuspid with hook	-12°	+2°	.122"	R	●	BTP-M8-122	BTP-M2-122
				L	●	BTP-M8-123	BTP-M2-123
$\frac{5}{5}$ 2 nd Bicuspid	-17°	+2°	.122"	R	●	BTP-M8-124	BTP-M2-124
				L	●	BTP-M8-125	BTP-M2-125
$\frac{5}{5}$ 2 nd Bicuspid with hook	-17°	+2°	.122"	R	●	BTP-M8-126	BTP-M2-126
				L	●	BTP-M8-127	BTP-M2-127

Full Kits ▲▼

Kits	.018	.022
Upper/Lower 5x5 Hook on 3	BKP-R8-102	BKP-R2-102
Upper/Lower 5x5 Hooks on 3,4 & 5	BKP-R8-104	BKP-R2-104

Full Kits ▲▼

Kits	.018	.022
Upper/Lower 5x5 Hook on 3	BKP-M8-102*	BKP-M2-102*
Upper/Lower 5x5 Hooks on 3,4 & 5	BKP-M8-104*	BKP-M2-104*
Upper/Lower 5x5 Hook on 3	BKP-M8-202	BKP-M2-202
Upper/Lower 5x5 Hooks on 3,4 & 5	BKP-M8-204	BKP-M2-204

* Cuspid brackets in these Kits are having 0 deg torque in uppers and -6 deg torque in lowers.

Other kits have -7 deg torque in uppers and -6 deg torque in lowers.

For any other cuspid torque combination, please place order for individual brackets.



Highest Quality Material

Made from high quality poly crystalline ceramic

Smooth, Strong and

Contoured Tie Wings
For added patient comfort

Archwire Slot Design

Diamond and heat polished for superior sliding mechanics

Removable Color Coding

For easy bracket selection

Compound Contour Base

Provides simplified and accurate bracket placement

Ample Tie Wing Area

For easy bracket ligation

Dovetail Bonding Base

Provides superior mechanical bond strength and predictable debonding

Ultra-Smooth, Strong Hooks

For added patient comfort and secure engagement of elastics



Low Profile Translucent | Dove Tail Grooves

Micro Crack Free | 99.9% Pure Alumina

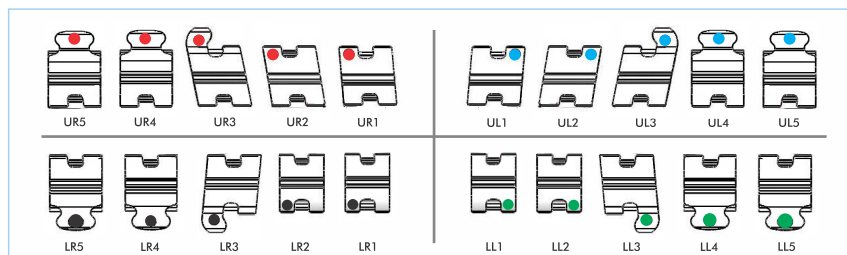



Roth Prescription

Maxillary ▲

Tooth	Torque	Angle	Width	R/L	ID	.018	.022
$\frac{1}{1}$ Central	+12°	+5°	.127"	R	●	BTD-R8-001	BTD-R2-001
				L	●	BTD-R8-002	BTD-R2-002
$\frac{2}{2}$ Lateral	+8°	+9°	.125"	R	●	BTD-R8-003	BTD-R2-003
				L	●	BTD-R8-004	BTD-R2-004
$\frac{3}{3}$ Cuspid with Hook	0°	+11°	.128"	R	●	BTD-R8-005	BTD-R2-005
				L	●	BTD-R8-006	BTD-R2-006
$\frac{4}{5}$ / $\frac{4}{5}$ 1 st & 2 nd Bicuspid	-7°	0°	.128"	R	●	BTD-R8-009	BTD-R2-009
				L	●	BTD-R8-010	BTD-R2-010
$\frac{4}{5}$ / $\frac{4}{5}$ 1 st & 2 nd Bicuspid Hk	-7°	0°	.128"	R	●	BTD-R8-011	BTD-R2-011
				L	●	BTD-R8-012	BTD-R2-012

MBT Prescription

Maxillary ▲

Tooth	Torque	Angle	Width	R/L	ID	.018	.022
$\frac{1}{1}$ Central	+17°	+4°	.125"	R	●	BTD-M8-101	BTD-M2-101
				L	●	BTD-M8-102	BTD-M2-102
$\frac{2}{2}$ Lateral	+10°	+8°	.122"	R	●	BTD-M8-103	BTD-M2-103
				L	●	BTD-M8-104	BTD-M2-104
$\frac{3}{3}$ Cuspid with hook	0°	+9°	.122"	R	●	BTD-M8-105	BTD-M2-105
				L	●	BTD-M8-106	BTD-M2-106
$\frac{3}{3}$ Cuspid with hook	-7°	+9°	.122"	R	●	BTD-M8-107	BTD-M2-107
				L	●	BTD-M8-108	BTD-M2-108
$\frac{4}{5}$ / $\frac{4}{5}$ 1 st & 2 nd Bicuspid	-7°	0°	.122"	R	●	BTD-M8-109	BTD-M2-109
				L	●	BTD-M8-110	BTD-M2-110
$\frac{4}{5}$ / $\frac{4}{5}$ 1 st & 2 nd Bicuspid Hk	-7°	0°	.122"	R	●	BTD-M8-111	BTD-M2-111
				L	●	BTD-M8-112	BTD-M2-112

Roth Prescription

Mandibular ▼

Tooth	Torque	Angle	Width	R/L	ID	.018	.022
$\frac{1}{2}$ / $\frac{1}{2}$ Lower Anterior	0°	0°	.110"	R	●	BTD-R8-014	BTD-R2-014
				L	●	BTD-R8-015	BTD-R2-015
$\frac{3}{3}$ Cuspid With hook	-11°	+5°	.126"	R	●	BTD-R8-016	BTD-R2-016
				L	●	BTD-R8-017	BTD-R2-017
$\frac{4}{4}$ 1 st Bicuspid	-17°	0°	.128"	R	●	BTD-R8-020	BTD-R2-020
				L	●	BTD-R8-021	BTD-R2-021
$\frac{4}{4}$ 1 st Bicuspid with hook	-17°	0°	.128"	R	●	BTD-R8-022	BTD-R2-022
				L	●	BTD-R8-023	BTD-R2-023
$\frac{5}{5}$ 2 nd Bicuspid	-22°	0°	.128"	R	●	BTD-R8-024	BTD-R2-024
				L	●	BTD-R8-025	BTD-R2-025
$\frac{5}{5}$ 2 nd Bicuspid with hook	-22°	0°	.128"	R	●	BTD-R8-026	BTD-R2-026
				L	●	BTD-R8-027	BTD-R2-027

MBT Prescription

Mandibular ▼

Tooth	Torque	Angle	Width	R/L	ID	.018	.022
$\frac{1}{2}$ / $\frac{1}{2}$ Lower Anterior	-6°	0°	.116"	R	●	BTD-M8-114	BTD-M2-114
				L	●	BTD-M8-115	BTD-M2-115
$\frac{3}{3}$ Cuspid with hook	0°	+3°	.122"	R	●	BTD-M8-116	BTD-M2-116
				L	●	BTD-M8-117	BTD-M2-117
$\frac{3}{3}$ Cuspid with hook	-6°	+3°	.122"	R	●	BTD-M8-118	BTD-M2-118
				L	●	BTD-M8-119	BTD-M2-119
$\frac{4}{4}$ 1 st Bicuspid	-12°	+2°	.122"	R	●	BTD-M8-120	BTD-M2-120
				L	●	BTD-M8-121	BTD-M2-121
$\frac{4}{4}$ 1 st Bicuspid with hook	-12°	+2°	.122"	R	●	BTD-M8-122	BTD-M2-122
				L	●	BTD-M8-123	BTD-M2-123
$\frac{5}{5}$ 2 nd Bicuspid	-17°	+2°	.122"	R	●	BTD-M8-124	BTD-M2-124
				L	●	BTD-M8-125	BTD-M2-125
$\frac{5}{5}$ 2 nd Bicuspid with hook	-17°	+2°	.122"	R	●	BTD-M8-126	BTD-M2-126
				L	●	BTD-M8-127	BTD-M2-127

Full Kits ▲▼

Kits	.018	.022
Upper/Lower 5x5 Hook on 3	BKD-R8-102	BKD-R2-102
Upper/Lower 5x5 Hooks on 3,4 & 5	BKD-R8-104	BKD-R2-104

Full Kits ▲▼

Kits	.018	.022
Upper/Lower 5x5 Hook on 3	BKD-M8-102*	BKD-M2-102*
Upper/Lower 5x5 Hooks on 3,4 & 5	BKD-M8-104*	BKD-M2-104*
Upper/Lower 5x5 Hook on 3	BKD-M8-202	BKD-M2-202
Upper/Lower 5x5 Hooks on 3,4 & 5	BKD-M8-204	BKD-M2-204

* Cuspid brackets in these Kits are having 0 deg torque in uppers and -6 deg torque in lowers.

Other kits have -7 deg torque in uppers and -6 deg torque in lowers.

For any other cuspid torque combination, please place order for individual brackets.



Removable Color Coded ID Dot
For easy bracket selection

Ultra-Smooth, Strong Hooks
For added patient comfort and secure engagement of elastics

Smooth, Strong and Contoured Tie Wings
For added patient comfort

Ample Tie Wing Area
For easy bracket ligation

Archwire Slot Design
Resists deformation and less friction for superior sliding mechanics

Dovetail Bonding Base
Provides superior mechanical bond strength and predictable debonding

Compound Contour Base
Provides simplified and accurate bracket placement

Highest Quality Material
Made from high quality poly urethane composite

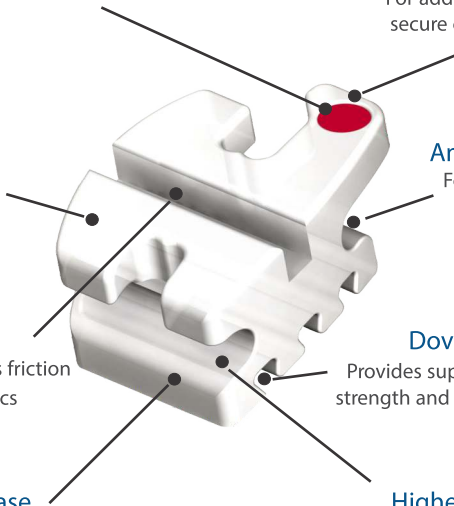

Compare to
Orthoflex™ by Ortho Technology
Quantum™ by MaseL, Superior™ by Dynaflex

Nano Particle Coating for highest Stain Resistance

Pure Mechanical Bonding | Strong Advanced PU Material

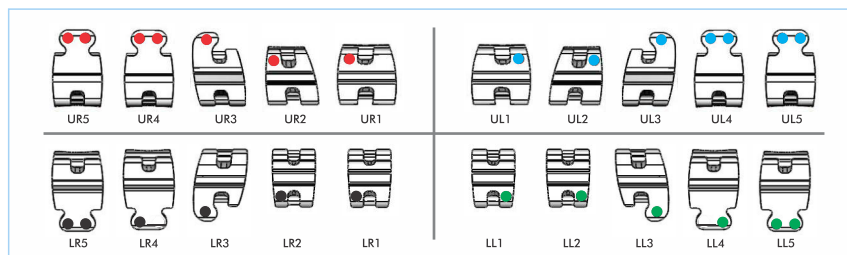



Roth Prescription

Maxillary ▲

Tooth	Torque	Angle	Width	R/L	ID	.018	.022
$\frac{1}{1}$ 1	Central	+12° +5°	.155"	R ● L ●	●	BTE-R8-001 BTE-R8-002	BTE-R2-001 BTE-R2-002
$\frac{2}{2}$ 2	Lateral	+8° +9°	.133"	R ● L ●	●	BTE-R8-003 BTE-R8-004	BTE-R2-003 BTE-R2-004
$\frac{3}{3}$ 3	Cuspid with Hook	0° +11°	.131"	R ● L ●	●	BTE-R8-005 BTE-R8-006	BTE-R2-005 BTE-R2-006
$\frac{4}{5}$ $\frac{4}{5}$	1 st & 2 nd Bicuspid	-7° 0°	.130"	R ● L ●	●	BTE-R8-009 BTE-R8-010	BTE-R2-009 BTE-R2-010
$\frac{4}{5}$ $\frac{4}{5}$	1 st & 2 nd Bicuspid Hk	-7° 0°	.130"	R ● L ●	●	BTE-R8-011 BTE-R8-012	BTE-R2-011 BTE-R2-012

MBT Prescription

Maxillary ▲

Tooth	Torque	Angle	Width	R/L	ID	.018	.022
$\frac{1}{1}$ 1	Central	+17° +4°	.125"	R ● L ●	●	BTE-M8-101 BTE-M8-102	BTE-M2-101 BTE-M2-102
$\frac{2}{2}$ 2	Lateral	+10° +8°	.122"	R ● L ●	●	BTE-M8-103 BTE-M8-104	BTE-M2-103 BTE-M2-104
$\frac{3}{3}$ 3	Cuspid with hook	0° +9°	.122"	R ● L ●	●	BTE-M8-105 BTE-M8-106	BTE-M2-105 BTE-M2-106
$\frac{3}{3}$ 3	Cuspid with hook	-7° +9°	.122"	R ● L ●	●	BTE-M8-107 BTE-M8-108	BTE-M2-107 BTE-M2-108
$\frac{4}{5}$ $\frac{4}{5}$	1 st & 2 nd Bicuspid	-7° 0°	.122"	R ● L ●	●	BTE-M8-109 BTE-M8-110	BTE-M2-109 BTE-M2-110
$\frac{4}{5}$ $\frac{4}{5}$	1 st & 2 nd Bicuspid Hk	-7° 0°	.122"	R ● L ●	●	BTE-M8-111 BTE-M8-112	BTE-M2-111 BTE-M2-112

Roth Prescription

Mandibular ▼

Tooth	Torque	Angle	Width	R/L	ID	.018	.022
$\frac{1}{2}$ $\frac{1}{2}$	Lower Anterior	0° 0°	.110"	R ● L ●	●	BTE-R8-014 BTE-R8-015	BTE-R2-014 BTE-R2-015
$\frac{3}{3}$ 3	Cuspid With hook	-11° +5°	.133"	R ● L ●	●	BTE-R8-016 BTE-R8-017	BTE-R2-016 BTE-R2-017
$\frac{4}{4}$ 4	1 st Bicuspid	-17° 0°	.133"	R ● L ●	●	BTE-R8-020 BTE-R8-021	BTE-R2-020 BTE-R2-021
$\frac{4}{4}$ 4	1 st Bicuspid with hook	-17° 0°	.133"	R ● L ●	●	BTE-R8-022 BTE-R8-023	BTE-R2-022 BTE-R2-023
$\frac{5}{5}$ 5	2 nd Bicuspid	-22° 0°	.133"	R ● L ●	●	BTE-R8-024 BTE-R8-025	BTE-R2-024 BTE-R2-025
$\frac{5}{5}$ 5	2 nd Bicuspid with hook	-22° 0°	.133"	R ● L ●	●	BTE-R8-026 BTE-R8-027	BTE-R2-026 BTE-R2-027

MBT Prescription

Mandibular ▼

Tooth	Torque	Angle	Width	R/L	ID	.018	.022
$\frac{1}{2}$ $\frac{1}{2}$	Lower Anterior	-6° 0°	.116"	R ● L ●	●	BTE-M8-114 BTE-M8-115	BTE-M2-114 BTE-M2-115
$\frac{3}{3}$ 3	Cuspid with hook	0° +3°	.122"	R ● L ●	●	BTE-M8-116 BTE-M8-117	BTE-M2-116 BTE-M2-117
$\frac{3}{3}$ 3	Cuspid with hook	-6° +3°	.122"	R ● L ●	●	BTE-M8-118 BTE-M8-119	BTE-M2-118 BTE-M2-119
$\frac{4}{4}$ 4	1 st Bicuspid	-12° +2°	.122"	R ● L ●	●	BTE-M8-120 BTE-M8-121	BTE-M2-120 BTE-M2-121
$\frac{4}{4}$ 4	1 st Bicuspid with hook	-12° +2°	.122"	R ● L ●	●	BTE-M8-122 BTE-M8-123	BTE-M2-122 BTE-M2-123
$\frac{5}{5}$ 5	2 nd Bicuspid	-17° +2°	.122"	R ● L ●	●	BTE-M8-124 BTE-M8-125	BTE-M2-124 BTE-M2-125
$\frac{5}{5}$ 5	2 nd Bicuspid with hook	-17° +2°	.122"	R ● L ●	●	BTE-M8-126 BTE-M8-127	BTE-M2-126 BTE-M2-127

Full Kits ▲▼

Kits	.018	.022
Upper/Lower 5x5 Hook on 3	BKE-R8-102	BKE-R2-102
Upper/Lower 5x5 Hooks on 3,4 & 5	BKE-R8-104	BKE-R2-104

Full Kits ▲▼

Kits	.018	.022
Upper/Lower 5x5 Hook on 3	BKE-M8-102*	BKE-M2-102*
Upper/Lower 5x5 Hooks on 3,4 & 5	BKE-M8-104*	BKE-M2-104*
Upper/Lower 5x5 Hook on 3	BKE-M8-202	BKE-M2-202
Upper/Lower 5x5 Hooks on 3,4 & 5	BKE-M8-204	BKE-M2-204

* Cuspid brackets in these Kits are having 0 deg torque in uppers and -6 deg torque in lowers. Other kits have -7 deg torque in uppers and -6 deg torque in lowers. For any other cuspid torque combination, please place order for individual brackets.



Advanced 17-4 low nickel alloy
for maximum strength in thinnest walls
and zero slot collapse.

ZeroF ultra low friction slot
Advanced polishing process creates mirror
finish by removing high surface peaks at
molecular level.

Beveled tie wings
To reduce the bracket visibility from front
without compromising on strength.

Rounded tie wings
For patient comfort

CNC milled slot
For precision and smoothness.

Clip made of Nitinol
For effortless repeated opening & closing
tested for more than 1000 cycles.

80 Gauge mesh pad
Compound contoured diagonal
mesh pad for maximum bonding
strength and zero rocking.

SecureLok Hooks

Offer best locking of chains and accessories.
Due to thinnest hook stem design large amount
undercut is present beneath the half round ball of
hook and chains will not slip out in between the
patient appointments.

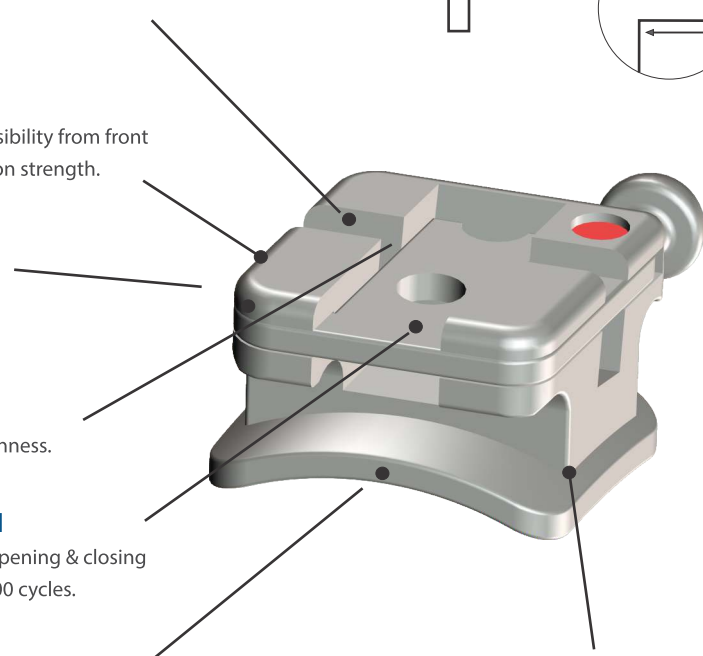
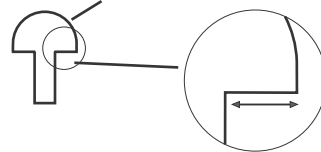

Palladium alloy braze
Assures strongest possible brazed
joint and resists electrolytic reaction
that can cause brazing failure during use.

- **CNC Milled Slot**
- **NiTi Clip**
- **Metal Injection Molded**
- **80 Mesh Pad**

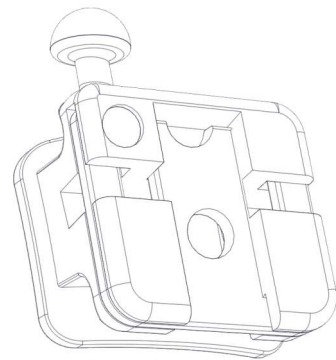

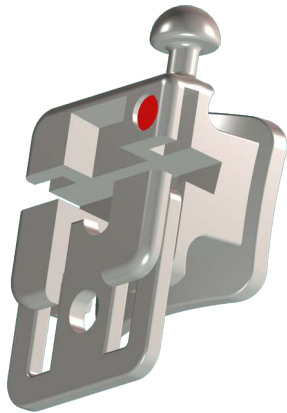

MBT Prescription ▲

Maxillary ▲

	Tooth	Torque	Angle	Width	R/L	ID	.022
1 1	Central	+17°	+4°	.113"	R	●	BTA-M2-101
					L	●	BTA-M2-102
2 2	Lateral	+10°	+8°	.106"	R	●	BTA-M2-103
					L	●	BTA-M2-104
3 3	Cuspid with hook	0°	+9°	.119"	R	●	BTA-M2-105
					L	●	BTA-M2-106
3 3	Cuspid with hook	-7°	+9°	.119"	R	●	BTA-M2-109
					L	●	BTA-M2-110
4/5 4/5	Bicuspid with hook	-7°	0°	.110"	R	●	BTA-M2-113
					L	●	BTA-M2-114
4/5 4/5	Bicuspid	-7°	0°	.110"	R	●	BTA-M2-115R
					L	●	BTA-M2-115L

MBT Prescription

Mandibular ▼

	Tooth	Torque	Angle	Width	R/L	ID	.022
1/2 1/2	Lower Anterior	-6°	0°	.093"	R	●	BTA-M2-119R
					L	●	BTA-M2-119L
3 3	Cuspid with hook	-6°	+3°	.108"	R	●	BTA-M2-120
					L	●	BTA-M2-121
3 3	Cuspid with hook	0°	+3°	.108"	R	●	BTA-M2-122
					L	●	BTA-M2-123
4 4	1 st Bicuspid with hook	-12°	+2°	.110"	R	●	BTA-M2-128
					L	●	BTA-M2-129
4 4	1 st Bicuspid	-12°	+2°	.110"	R	●	BTA-M2-130
					L	●	BTA-M2-131
5 5	2 nd Bicuspid with hook	-17°	+2°	.110"	R	●	BTA-M2-136
					L	●	BTA-M2-137
5 5	2 nd Bicuspid	-17°	+2°	.110"	R	●	BTA-M2-138
					L	●	BTA-M2-139

Full Kits ▲▼

Kits	.022
Upper/Lower 5x5 Hook on 3*	BKA-M2-102*
Upper/Lower 5x5 Hooks on 3,4 & 5*	BKA-M2-104*

* Cuspid brackets in these Kits are having 0 deg torque in uppers and -6 deg torque in lowers. For any other cuspid torque combination, please place order for individual brackets.

We are sure that you won't miss your conventional brackets.....

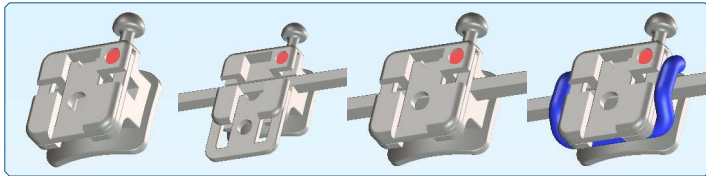

Fully versatile

Use with or without 'O'ring

No training required

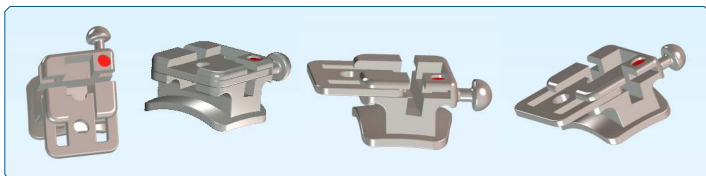

No special instruments to open or close

Use with or without 'O'ring



End to end rotation control



No Friction



Generous under tie wing area



Advanced 17-4 low nickel alloy
for maximum strength in thinnest walls and zero slot collapse.

ZeroF ultra low friction slot
Advanced polishing process creates mirror finish by removing high surface peaks at molecular level.

Beveled tie wings
To reduce the bracket visibility from front without compromising on strength.

Rounded tie wings
For patient comfort

CNC milled slot
For precision and smoothness.

Centre scribe line
For accurate bracket placement in line with the long axis of tooth.

80 Gauge mesh pad
Compound contoured diagonal mesh pad for maximum bonding strength and zero rocking.

SecureLok Hooks

Offer best locking of chains and accessories. Due to thinnest hook stem design large amount undercut is present beneath the half round ball of hook and chains will not slip out in between the patient appointments.

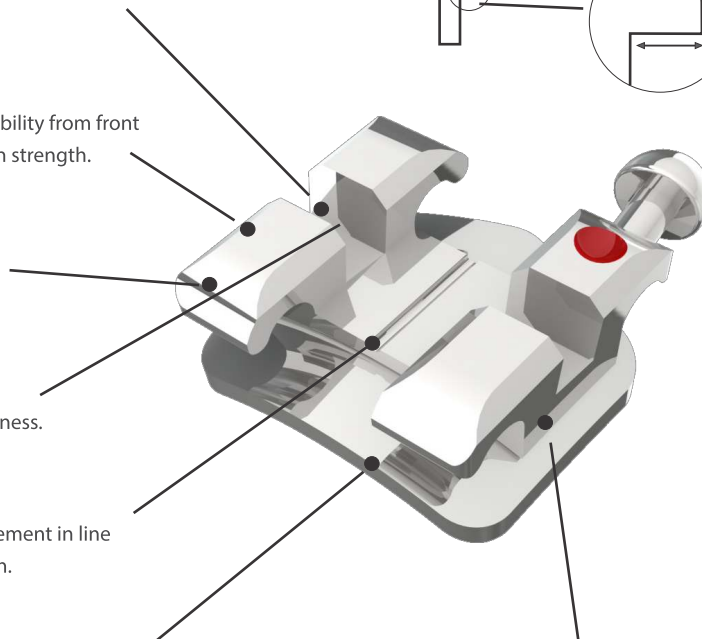
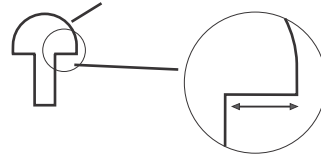

Palladium alloy braze
Assures strongest possible brazed joint and resists electrolytic reaction that can cause brazing failure during use.

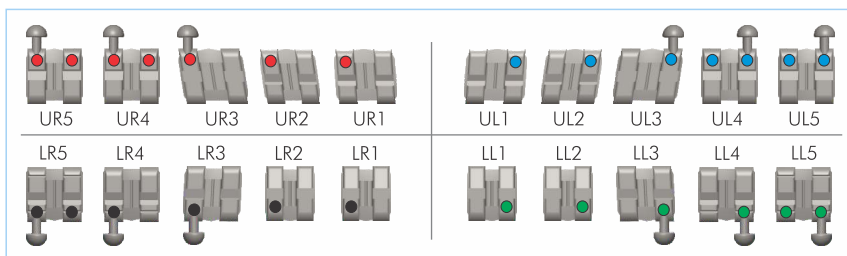

➔ **CNC Milled Slot**

➔ **CAD Design**

➔ **Metal Injection Molded**

➔ **80 Mesh Pad**

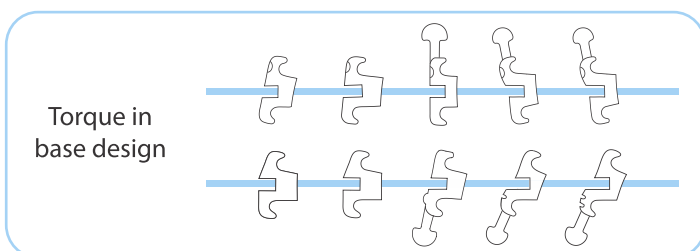

Permanent ID marks
With enhanced colors for easy identification

Large tie wings design
for double tying

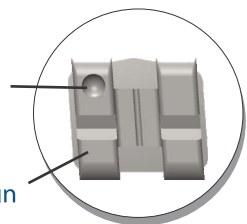



Roth Prescription

Maxillary ▲

Tooth	Torque	Angle	Width	R/L	ID	.018	.022
$\frac{1}{1}$ Central	+12°	+5°	.113"	R	●	BTS-R8-501	BTS-R2-501
				L	●	BTS-R8-502	BTS-R2-502
$\frac{2}{2}$ Lateral	+8°	+9°	.106"	R	●	BTS-R8-503	BTS-R2-503
				L	●	BTS-R8-504	BTS-R2-504
$\frac{3}{3}$ Cuspid with hook	0°	+11°	.119"	R	●	BTS-R8-505	BTS-R2-505
				L	●	BTS-R8-506	BTS-R2-506
$\frac{4}{5}$ Bicuspid	-7°	0°	.110"	R	●	BTS-R8-509R	BTS-R2-509R
				L	●	BTS-R8-509L	BTS-R2-509L
$\frac{4}{5}$ Bicuspid with hook	-7°	0°	.110"	R	●	BTS-R8-510	BTS-R2-510
				L	●	BTS-R8-511	BTS-R2-511

MBT Prescription

Maxillary ▲

Tooth	Torque	Angle	Width	R/L	ID	.018	.022
$\frac{1}{1}$ Central	+17°	+4°	.113"	R	●	BTS-M8-501	BTS-M2-501
				L	●	BTS-M8-502	BTS-M2-502
$\frac{2}{2}$ Lateral	+10°	+8°	.106"	R	●	BTS-M8-503	BTS-M2-503
				L	●	BTS-M8-504	BTS-M2-504
$\frac{3}{3}$ Cuspid with hook	0°	+9°	.119"	R	●	BTS-M8-505	BTS-M2-505
				L	●	BTS-M8-506	BTS-M2-506
$\frac{3}{3}$ Cuspid with hook	-7°	+9°	.119"	R	●	BTS-M8-509	BTS-M2-509
				L	●	BTS-M8-510	BTS-M2-510
$\frac{4}{5}$ Bicuspid with hook	-7°	0°	.110"	R	●	BTS-M8-513	BTS-M2-513
				L	●	BTS-M8-514	BTS-M2-514
$\frac{4}{5}$ Bicuspid	-7°	0°	.110"	R	●	BTS-M8-515R	BTS-M2-515R
				L	●	BTS-M8-515L	BTS-M2-515L

Roth Prescription

Mandibular ▼

Tooth	Torque	Angle	Width	R/L	ID	.018	.022
$\frac{1}{2}$ Lower Anterior	0°	0°	.093"	R	●	BTS-R8-515R	BTS-R2-515R
				L	●	BTS-R8-515L	BTS-R2-515L
$\frac{3}{3}$ Cuspid With hook	-11°	+5°	.108"	R	●	BTS-R8-516	BTS-R2-516
				L	●	BTS-R8-517	BTS-R2-517
$\frac{4}{4}$ 1 st Bicuspid	-17°	0°	.110"	R	●	BTS-R8-520R	BTS-R2-520R
				L	●	BTS-R8-520L	BTS-R2-520L
$\frac{4}{4}$ 1 st Bicuspid with hook	-17°	0°	.110"	R	●	BTS-R8-521	BTS-R2-521
				L	●	BTS-R8-522	BTS-R2-522
$\frac{5}{5}$ 2 nd Bicuspid	-22°	0°	.110"	R	●	BTS-R8-526R	BTS-R2-526R
				L	●	BTS-R8-526L	BTS-R2-526L
$\frac{5}{5}$ 2 nd Bicuspid with hook	-22°	0°	.110"	R	●	BTS-R8-527	BTS-R2-527
				L	●	BTS-R8-528	BTS-R2-528

MBT Prescription

Mandibular ▼

Tooth	Torque	Angle	Width	R/L	ID	.018	.022
$\frac{1}{2}$ Lower Anterior	-6°	0°	.093"	R	●	BTS-M8-519R	BTS-M2-519R
				L	●	BTS-M8-519L	BTS-M2-519L
$\frac{3}{3}$ Cuspid with hook	-6°	+3°	.108"	R	●	BTS-M8-520	BTS-M2-520
				L	●	BTS-M8-521	BTS-M2-521
$\frac{3}{3}$ Cuspid with hook	0°	+3°	.108"	R	●	BTS-M8-522	BTS-M2-522
				L	●	BTS-M8-523	BTS-M2-523
$\frac{4}{4}$ 1 st Bicuspid with hook	-12°	+2°	.110"	R	●	BTS-M8-528	BTS-M2-528
				L	●	BTS-M8-529	BTS-M2-529
$\frac{4}{4}$ 1 st Bicuspid	-12°	+2°	.110"	R	●	BTS-M8-530	BTS-M2-530
				L	●	BTS-M8-531	BTS-M2-531
$\frac{5}{5}$ 2 nd Bicuspid with hook	-17°	+2°	.110"	R	●	BTS-M8-536	BTS-M2-536
				L	●	BTS-M8-537	BTS-M2-537
$\frac{5}{5}$ 2 nd Bicuspid	-17°	+2°	.110"	R	●	BTS-M8-538	BTS-M2-538
				L	●	BTS-M8-539	BTS-M2-539

Full Kits ▲▼

Kits	.018	.022
Upper/Lower 5x5 Hook on 3	BKS-R8-502	BKS-R2-502
Upper/Lower 5x5 Hooks on 3,4 & 5	BKS-R8-504	BKS-R2-504

Full Kits ▲▼

Kits	.018	.022
Upper/Lower 5x5 Hook on 3*	BKS-M8-502*	BKS-M2-502*
Upper/Lower 5x5 Hooks on 3,4 & 5*	BKS-M8-504*	BKS-M2-504*
Upper/Lower 5x5 Hook on 3	BKS-M8-602	BKS-M2-602
Upper/Lower 5x5 Hooks on 3,4 & 5	BKS-M8-604	BKS-M2-604

* Cuspid brackets in these Kits are having 0 deg torque in uppers and -6 deg torque in lowers.

Other kits have -7 deg torque in uppers and -6 deg torque in lowers.

For any other cuspid torque combination, please place order for individual brackets.



High gingival tie wings
on bicuspid for tissue avoidance,
easier ligation and better hygiene
Big help when bonding partially
erupted bicuspids

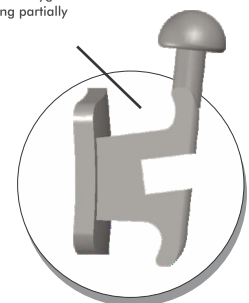

Advanced 17 -4 low nickel alloy
for maximum strength in thinnest walls
and zero slot collapse.

ZeroF ultra low friction slot
Advanced polishing process creates mirror
finish by removing high surface peaks at
molecular level.

Rounded tie wings
For patient comfort

CNC milled slot
For precision and smoothness.

Centre scribe line
For accurate bracket placement in line
with the long axis of tooth.

80 Gauge mesh pad
Compound contoured diagonal
mesh pad for maximum bonding
strength and zero rocking.



Palladium alloy braze
Assures strongest possible brazed
joint and resists electrolytic reaction
that can cause brazing failure during use.

Exact in - out dimensions.

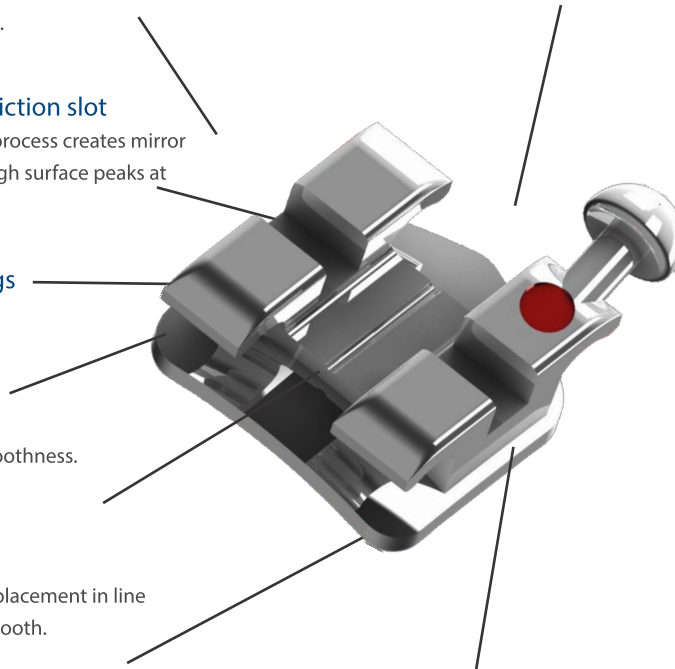

Permanent ID marks
with enhanced colors
for easy identification

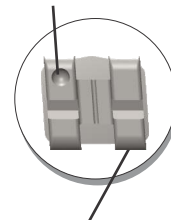

Large tie wings design
for double tying

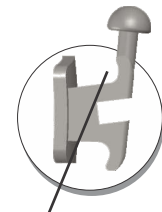

High gingival tie wings
on bicuspid for tissue avoidance,
easier ligation and better hygiene
Big help when bonding partially
erupted bicuspids

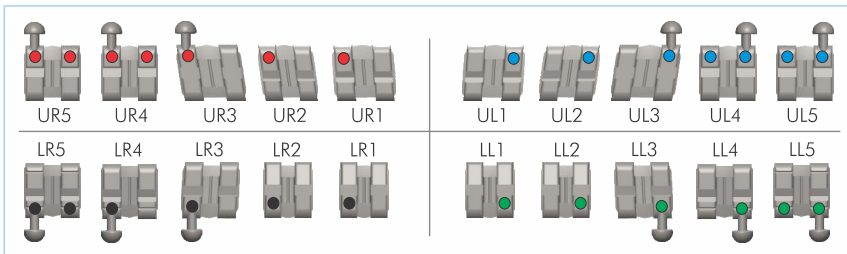

Torque in
base design

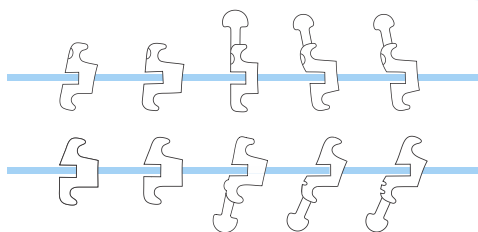



Roth Prescription

Maxillary ▲

Tooth	Torque	Angle	Width	R/L	ID	.018	.022	
1 1	Central	+12°	+5°	.113"	R	●	BTM-R8-001	BTM-R2-001
					L	●	BTM-R8-002	BTM-R2-002
2 2	Lateral	+8°	+9°	.106"	R	●	BTM-R8-003	BTM-R2-003
					L	●	BTM-R8-004	BTM-R2-004
3 3	Cuspid with hook	0°	+11°	.119"	R	●	BTM-R8-005	BTM-R2-005
					L	●	BTM-R8-006	BTM-R2-006
4 4	Bicuspid	-7°	0°	.110"	R	●	BTM-R8-009R	BTM-R2-009R
					L	●	BTM-R8-009L	BTM-R2-009L
4 4	Bicuspid with hook	-7°	0°	.110"	R	●	BTM-R8-010	BTM-R2-010
					L	●	BTM-R8-011	BTM-R2-011

MBT Prescription

Maxillary ▲

Tooth	Torque	Angle	Width	R/L	ID	.018	.022	
1 1	Central	+17°	+4°	.113"	R	●	BTM-M8-101	BTM-M2-101
					L	●	BTM-M8-102	BTM-M2-102
2 2	Lateral	+10°	+8°	.106"	R	●	BTM-M8-103	BTM-M2-103
					L	●	BTM-M8-104	BTM-M2-104
3 3	Cuspid with hook	0°	+9°	.119"	R	●	BTM-M8-105	BTM-M2-105
					L	●	BTM-M8-106	BTM-M2-106
3 3	Cuspid with hook	-7°	+9°	.119"	R	●	BTM-M8-109	BTM-M2-109
					L	●	BTM-M8-110	BTM-M2-110
4 4	Bicuspid with hook	-7°	0°	.110"	R	●	BTM-M8-113	BTM-M2-113
					L	●	BTM-M8-114	BTM-M2-114
4 4	Bicuspid	-7°	0°	.110"	R	●	BTM-M8-115R	BTM-M2-115R
					L	●	BTM-M8-115L	BTM-M2-115L

Roth Prescription

Mandibular ▼

Tooth	Torque	Angle	Width	R/L	ID	.018	.022	
1/2 1/2	Lower Anterior	0°	0°	.093"	R	●	BTM-R8-015R	BTM-R2-015R
					L	●	BTM-R8-015L	BTM-R2-015L
3 3	Cuspid With hook	-11°	+5°	.108"	R	●	BTM-R8-016	BTM-R2-016
					L	●	BTM-R8-017	BTM-R2-017
4 4	1 st Bicuspid	-17°	0°	.110"	R	●	BTM-R8-020R	BTM-R2-020R
					L	●	BTM-R8-020L	BTM-R2-020L
4 4	1 st Bicuspid with hook	-17°	0°	.110"	R	●	BTM-R8-021	BTM-R2-021
					L	●	BTM-R8-022	BTM-R2-022
5 5	2 nd Bicuspid	-22°	0°	.110"	R	●	BTM-R8-026R	BTM-R2-026R
					L	●	BTM-R8-026L	BTM-R2-026L
5 5	2 nd Bicuspid with hook	-22°	0°	.110"	R	●	BTM-R8-027	BTM-R2-027
					L	●	BTM-R8-028	BTM-R2-028

MBT Prescription

Mandibular ▼

Tooth	Torque	Angle	Width	R/L	ID	.018	.022	
1/2 1/2	Lower Anterior	-6°	0°	.093"	R	●	BTM-M8-119R	BTM-M2-119R
					L	●	BTM-M8-119L	BTM-M2-119L
3 3	Cuspid with hook	-6°	+3°	.108"	R	●	BTM-M8-120	BTM-M2-120
					L	●	BTM-M8-121	BTM-M2-121
3 3	Cuspid with hook	0°	+3°	.108"	R	●	BTM-M8-122	BTM-M2-122
					L	●	BTM-M8-123	BTM-M2-123
4 4	1 st Bicuspid with hook	-12°	+2°	.110"	R	●	BTM-M8-128	BTM-M2-128
					L	●	BTM-M8-129	BTM-M2-129
4 4	1 st Bicuspid	-12°	+2°	.110"	R	●	BTM-M8-130	BTM-M2-130
					L	●	BTM-M8-131	BTM-M2-131
5 5	2 nd Bicuspid with hook	-17°	+2°	.110"	R	●	BTM-M8-136	BTM-M2-136
					L	●	BTM-M8-137	BTM-M2-137
5 5	2 nd Bicuspid	-17°	+2°	.110"	R	●	BTM-M8-138	BTM-M2-138
					L	●	BTM-M8-139	BTM-M2-139

Roth Full Kits ▲▼

Kits	.018	.022
Upper/Lower 5x5 Hook on 3	BKM-R8-102	BKM-R2-102
Upper/Lower 5x5 Hooks on 3,4 & 5	BKM-R8-104	BKM-R2-104

MBT Full Kits ▲▼

Kits	.018	.022
Upper/Lower 5x5 Hook on 3*	BKM-M8-102*	BKM-M2-102*
Upper/Lower 5x5 Hooks on 3,4 & 5*	BKM-M8-104*	BKM-M2-104*
Upper/Lower 5x5 Hook on 3	BKM-M8-202	BKM-M2-202
Upper/Lower 5x5 Hooks on 3,4 & 5	BKM-M8-204	BKM-M2-204

* Cuspid brackets in these Kits are having -7 deg torque in uppers and -6 deg torque in lowers. Other kits have 0 deg torque in all cuspids. For any other cuspid torque combination, please place order for individual brackets.

SecureLok Hooks

Offer best locking of chains and accessories. Due to thinnest hook stem design large amount undercut is present beneath the half round ball of hook and chains will not slip out in between the patient appointments.

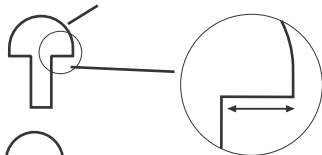

Full Round Hook on other brackets offer no resistance to dislodgement of chains

Half Round Hook with less under cut area again allows slippage of E-chain

Better than above two but still not enough locking due to thick stem of hook



Advanced 17-4 low nickel alloy

for maximum strength in thinnest walls and zero slot collapse.

ZeroF ultra low friction slot

Advanced polishing process creates mirror finish by removing high surface peaks at molecular level.

Beveled tie wings

To reduce the bracket visibility from front without compromising on strength.

Rounded tie wings

For patient comfort

CNC milled slot

For precision and smoothness.

Centre scribe line

For accurate bracket placement in line with the long axis of tooth.

80 Gauge mesh pad

Compound contoured diagonal mesh pad for maximum bonding strength and zero rocking.

SecureLok Hooks

Offer best locking of chains and accessories. Due to thinnest hook stem design large amount undercut is present beneath the half round ball of hook and chains will not slip out in between the patient appointments.

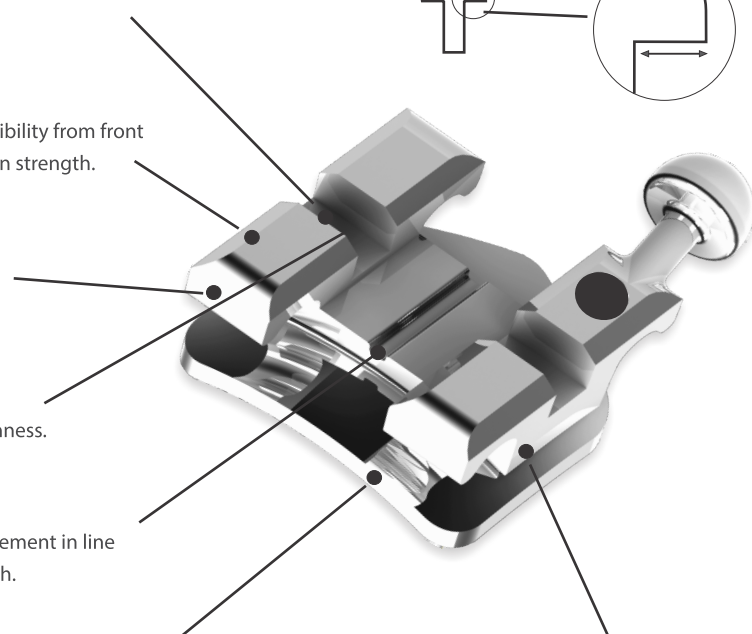
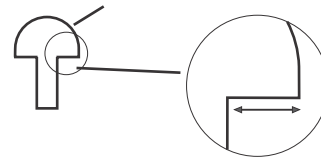

Palladium alloy braze

Assures strongest possible brazed joint and resists electrolytic reaction that can cause brazing failure during use.

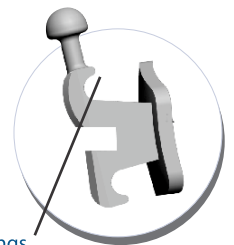

High gingival tie wings
on bicuspid for tissue avoidance, easier ligation and better hygiene. Big help when bonding partially erupted bicuspids

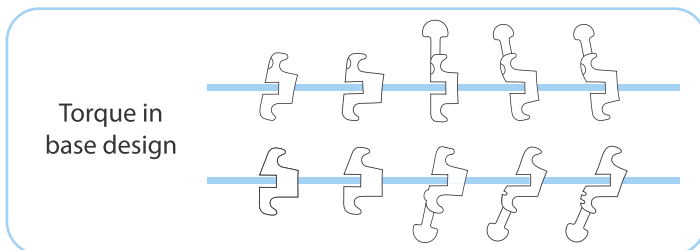
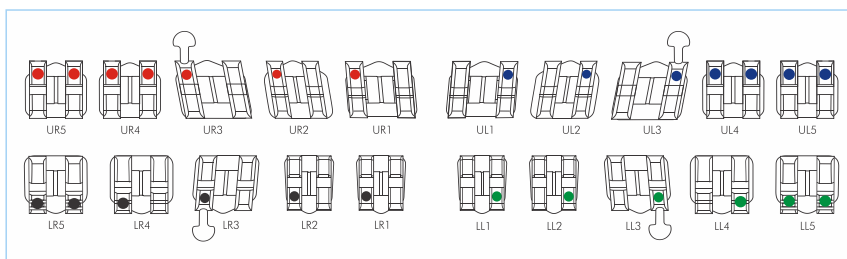

Torque in base design

Gingivally offset bicuspid brackets

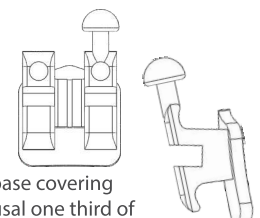

offer a large bonding base covering more area on the occlusal one third of buccal surface and increasing bond strength. Helps in fast eruption of partially erupted bicuspid



Roth Prescription

Maxillary ▲

Tooth	Torque	Angle	Width	R/L	ID	.018	.022
1 1 Central	+12°	+5°	.144"	R	●	BTS-R8-001	BTS-R2-001
				L	●	BTS-R8-002	BTS-R2-002
2 2 Lateral	+8°	+9°	.108"	R	●	BTS-R8-003	BTS-R2-003
				L	●	BTS-R8-004	BTS-R2-004
3 3 Cuspid with hook	0°	+11°	.136"	R	●	BTS-R8-005	BTS-R2-005
				L	●	BTS-R8-006	BTS-R2-006
3 3 Cuspid	0°	+11°	.136"	R	●	BTS-R8-007	BTS-R2-007
				L	●	BTS-R8-008	BTS-R2-008
4 4/5 Bicuspid	-7°	0°	.120"	R	●	BTS-R8-009R	BTS-R2-009R
				L	●	BTS-R8-009L	BTS-R2-009L
4 4/5 Bicuspid with hook	-7°	0°	.120"	R	●	BTS-R8-010	BTS-R2-010
				L	●	BTS-R8-011	BTS-R2-011
4 4/5 Bicuspid w/hook & offset	-7°	0°	.120"	R	●	BTS-R8-012	BTS-R2-012
				L	●	BTS-R8-013	BTS-R2-013
4 4/5 Bicuspid with offset	-7°	0°	.120"	R	●	BTS-R8-014R	BTS-R2-014R
				L	●	BTS-R8-014L	BTS-R2-014L

Roth Prescription

Mandibular ▼

Tooth	Torque	Angle	Width	R/L	ID	.018	.022
1/2 1/2 Lower Anterior	0°	0°	.098"	R	●	BTS-R8-015R	BTS-R2-015R
				L	●	BTS-R8-015L	BTS-R2-015L
3 3 Cuspid With hook	-11°	+5°	.128"	R	●	BTS-R8-016	BTS-R2-016
				L	●	BTS-R8-017	BTS-R2-017
3 3 Cuspid	-11°	+5°	.128"	R	●	BTS-R8-018	BTS-R2-018
				L	●	BTS-R8-019	BTS-R2-019
4 4 1 st Bicuspid	-17°	0°	.120"	R	●	BTS-R8-020R	BTS-R2-020R
				L	●	BTS-R8-020L	BTS-R2-020L
4 4 1 st Bicuspid with hook	-17°	0°	.120"	R	●	BTS-R8-021	BTS-R2-021
				L	●	BTS-R8-022	BTS-R2-022
4 4 1 st Bicuspid w/hook & offset	-17°	0°	.120"	R	●	BTS-R8-023	BTS-R2-023
				L	●	BTS-R8-024	BTS-R2-024
4 4 1 st Bicuspid with offset	-17°	0°	.120"	R	●	BTS-R8-025R	BTS-R2-025R
				L	●	BTS-R8-025L	BTS-R2-025L
5 5 2 nd Bicuspid	-22°	0°	.120"	R	●	BTS-R8-026R	BTS-R2-026R
				L	●	BTS-R8-026L	BTS-R2-026L
5 5 2 nd Bicuspid with hook	-22°	0°	.120"	R	●	BTS-R8-027	BTS-R2-027
				L	●	BTS-R8-028	BTS-R2-028
5 5 2 nd Bicuspid w/hook & offset	-22°	0°	.120"	R	●	BTS-R8-029	BTS-R2-029
				L	●	BTS-R8-030	BTS-R2-030
5 5 2 nd Bicuspid with offset	-22°	0°	.120"	R	●	BTS-R8-031R	BTS-R2-031R
				L	●	BTS-R8-031L	BTS-R2-031L

Full Kits ▲▼

Kits	.018	.022
Upper/Lower 5x5 No Hooks	BKS-R8-100	BKS-R2-100
Upper/Lower 5x5 No Hooks w/offset	BKS-R8-101	BKS-R2-101
Upper/Lower 5x5 Hook on 3	BKS-R8-102	BKS-R2-102
Upper/Lower 5x5 Hooks on 3 w/offset	BKS-R8-103	BKS-R2-103
Upper/Lower 5x5 Hook on 3,4,5	BKS-R8-104	BKS-R2-104
Upper/Lower 5x5 Hooks on 3,4 & 5 w/offset	BKS-R8-105	BKS-R2-105

* Cuspid brackets in these Kits are having -7 deg torque in uppers and -6 deg torque in lowers.
Other kits have 0 deg torque in all cuspids.
For any other cuspid torque combination, please place order for individual brackets.

MBT Prescription

Maxillary ▲

Tooth	Torque	Angle	Width	R/L	ID	.018	.022
1 1 Central	+17°	+4°	.144"	R	●	BTS-M8-101	BTS-M2-101
				L	●	BTS-M8-102	BTS-M2-102
2 2 Lateral	+10°	+8°	.108"	R	●	BTS-M8-103	BTS-M2-103
				L	●	BTS-M8-104	BTS-M2-104
3 3 Cuspid with hook	0°	+9°	.136"	R	●	BTS-M8-105	BTS-M2-105
				L	●	BTS-M8-106	BTS-M2-106
3 3 Cuspid	0°	+9°	.136"	R	●	BTS-M8-107	BTS-M2-107
				L	●	BTS-M8-108	BTS-M2-108
3 3 Cuspid with hook	-7°	+9°	.136"	R	●	BTS-M8-109	BTS-M2-109
				L	●	BTS-M8-110	BTS-M2-110
3 3 Cuspid	-7°	+9°	.136"	R	●	BTS-M8-111	BTS-M2-111
				L	●	BTS-M8-112	BTS-M2-112
4 4/5 Bicuspid with hook	-7°	0°	.120"	R	●	BTS-M8-113	BTS-M2-113
				L	●	BTS-M8-114	BTS-M2-114
4 4/5 Bicuspid	-7°	0°	.120"	R	●	BTS-M8-115R	BTS-M2-115R
				L	●	BTS-M8-115L	BTS-M2-115L
4 4/5 Bicuspid with offset	-7°	0°	.120"	R	●	BTS-M8-116R	BTS-M2-116R
				L	●	BTS-M8-116L	BTS-M2-116L
4 4/5 Bicuspid w/offer & offset	-7°	0°	.120"	R	●	BTS-M8-117	BTS-M2-117
				L	●	BTS-M8-118	BTS-M2-118

MBT Prescription

Mandibular ▼

Tooth	Torque	Angle	Width	R/L	ID	.018	.022
1/2 1/2 Lower Anterior	-6°	0°	.098"	R	●	BTS-M8-119R	BTS-M2-119R
				L	●	BTS-M8-119L	BTS-M2-119L
3 3 Cuspid with hook	-6°	+3°	.128"	R	●	BTS-M8-120	BTS-M2-120
				L	●	BTS-M8-121	BTS-M2-121
3 3 Cuspid with hook	0°	+3°	.128"	R	●	BTS-M8-122	BTS-M2-122
				L	●	BTS-M8-123	BTS-M2-123
3 3 Cuspid	-6°	+3°	.128"	R	●	BTS-M8-124	BTS-M2-124
				L	●	BTS-M8-125	BTS-M2-125
3 3 Cuspid	0°	+3°	.128"	R	●	BTS-M8-126	BTS-M2-126
				L	●	BTS-M8-127	BTS-M2-127
4 4 1 st Bicuspid with hook	-12°	+2°	.120"	R	●	BTS-M8-128	BTS-M2-128
				L	●	BTS-M8-129	BTS-M2-129
4 4 1 st Bicuspid	-12°	+2°	.120"	R	●	BTS-M8-130	BTS-M2-130
				L	●	BTS-M8-131	BTS-M2-131
4 4 1 st Bicuspid with offset	-12°	+2°	.120"	R	●	BTS-M8-132	BTS-M2-132
				L	●	BTS-M8-133	BTS-M2-133
4 4 1 st Bicuspid w/hook & offset	-12°	+2°	.120"	R	●	BTS-M8-134	BTS-M2-134
				L	●	BTS-M8-135	BTS-M2-135
5 5 2 nd Bicuspid with hook	-17°	+2°	.120"	R	●	BTS-M8-136	BTS-M2-136
				L	●	BTS-M8-137	BTS-M2-137
5 5 2 nd Bicuspid	-17°	+2°	.120"	R	●	BTS-M8-138	BTS-M2-138
				L	●	BTS-M8-139	BTS-M2-139
5 5 2 nd Bicuspid with offset	-17°	+2°	.120"	R	●	BTS-M8-140	BTS-M2-140
				L	●	BTS-M8-141	BTS-M2-141
5 5 2 nd Bicuspid w/hook & offset	-17°	+2°	.120"	R	●	BTS-M8-142	BTS-M2-142
				L	●	BTS-M8-143	BTS-M2-143

Permanent ID marks
With enhanced colors
for easy identification

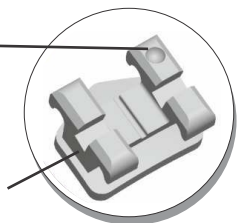

Large tie wings design
for double tying



Full Kits ▲▼

Kits	.018	.022
Upper/Lower 5x5 No Hooks*	BKS-M8-100*	BKS-M2-100*
Upper/Lower 5x5 No Hooks w/offset*	BKS-M8-101*	BKS-M2-101*
Upper/Lower 5x5 Hook on 3*	BKS-M8-102*	BKS-M2-102*
Upper/Lower 5x5 Hooks on 3 w/offset*	BKS-M8-103*	BKS-M2-103*
Upper/Lower 5x5 Hooks on 3,4,5*	BKS-M8-104*	BKS-M2-104*
Upper/Lower 5x5 Hooks on 3,4 & 5 w/offset*	BKS-M8-105*	BKS-M2-105*
Upper/Lower 5x5 No Hooks	BKS-M8-200	BKS-M2-200
Upper/Lower 5x5 No Hooks w/offset	BKS-M8-201	BKS-M2-201
Upper/Lower 5x5 Hook on 3	BKS-M8-202	BKS-M2-202
Upper/Lower 5x5 Hooks on 3 w/offset	BKS-M8-203	BKS-M2-203
Upper/Lower 5x5 Hooks on 3,4,5	BKS-M8-204	BKS-M2-204
Upper/Lower 5x5 Hooks on 3,4 & 5 w/offset	BKS-M8-205	BKS-M2-205

* Cuspid brackets in these Kits are having 0 deg torque in uppers and -6 deg torque in lowers. Other kits have -7 deg torque in uppers and -6 deg torque in lowers. For any other cuspid torque combination, please place order for individual brackets.

Full Kits

Ricketts Configuration ▲▼

0 Torque and 0 Angulation on both upper and lower bicuspid

Kits	.018	.022
Upper/Lower 5x5 No Hooks	BKS-B8-301	BKS-B2-301
Upper/Lower 5x5 Hook on 3	BKS-B8-302	BKS-B2-302

Hilgers Configuration

Kits	.018	.022
Upper/Lower 5x5 No Hooks	BKS-B8-303	BKS-B2-303
Upper/Lower 5x5 Hooks on 3	BKS-B8-304	BKS-B2-304
Upper/Lower 5x5 Hooks on 3,4,5	BKS-B8-305	BKS-B2-305

Hilgers Offsets Configuration

Kits	.018	.022
Upper/Lower 5x5 No Hooks	BKS-B8-306	BKS-B2-306
Upper/Lower 5x5 Hooks on 3	BKS-B8-307	BKS-B2-307
Upper/Lower 5x5 Hooks on 3,4 & 5	BKS-B8-308	BKS-B2-308



Bio- Progressive Ricketts/Hilgers Prescription

Maxillary ▲

Tooth	Torque	Angle	Width	R/L	ID	.018	.022
1 1 Central	+22°	+5°	.144"	R	●	BTS-B8-301	BTS-B2-301
				L	●	BTS-B8-302	BTS-B2-302
2 2 Lateral	+14°	+9°	.108"	R	●	BTS-B8-303	BTS-B2-303
				L	●	BTS-B8-304	BTS-B2-304
3 3 Cuspid	+7°	+9°	.136"	R	●	BTS-B8-305	BTS-B2-305
				L	●	BTS-B8-306	BTS-B2-306
3 3 Cuspid with hook	+7°	+9°	.136"	R	●	BTS-B8-307	BTS-B2-307
				L	●	BTS-B8-308	BTS-B2-308
4/5 4/5 Bicuspid	-7°	0°	.120"	R	●	BTS-B8-309R	BTS-B2-309R
				L	●	BTS-B8-309L	BTS-B2-309L
4/5 4/5 Bicuspid with hook	-7°	0°	.120"	R	●	BTS-B8-310	BTS-B2-310
				L	●	BTS-B8-311	BTS-B2-311
4/5 4/5 Bicuspid w/offer & offset	-7°	0°	.120"	R	●	BTS-B8-312	BTS-B2-312
				L	●	BTS-B8-313	BTS-B2-313
4/5 4/5 Bicuspid with offset	-7°	0°	.120"	R	●	BTS-B8-314R	BTS-B2-314R
				L	●	BTS-B8-314L	BTS-B2-314L
4/5 4/5 Bicuspid	0°	0°	.120"	R	●	BTS-B8-315R	BTS-B2-315R
				L	●	BTS-B8-315L	BTS-B2-315L
4/5 4/5 Bicuspid with hook	0°	0°	.120"	R	●	BTS-B8-316	BTS-B2-316
				L	●	BTS-B8-317	BTS-B2-317

Bio- Progressive Ricketts/Hilgers Prescription

Mandibular ▼

Tooth	Torque	Angle	Width	R/L	ID	.018	.022
1/2 1/2 Lower Anterior	0°	0°	.098"	R	●	BTS-B8-318R	BTS-B2-318R
				L	●	BTS-B8-318L	BTS-B2-318L
3 3 Cuspid with hook	+7°	+5°	.128"	R	●	BTS-B8-319	BTS-B2-319
				L	●	BTS-B8-320	BTS-B2-320
3 3 Cuspid	+7°	+5°	.128"	R	●	BTS-B8-321	BTS-B2-321
				L	●	BTS-B8-322	BTS-B2-322
4 4 1 st Bicuspid	-12°	0°	.120"	R	●	BTS-B8-323R	BTS-B2-323R
				L	●	BTS-B8-323L	BTS-B2-323L
4 4 1 st Bicuspid with hook	-12°	0°	.120"	R	●	BTS-B8-324	BTS-B2-324
				L	●	BTS-B8-325	BTS-B2-325
4 4 1 st Bicuspid with offset	-12°	0°	.120"	R	●	BTS-B8-326R	BTS-B2-326R
				L	●	BTS-B8-326L	BTS-B2-326L
4 4 1 st Bicuspid w/hook & offset	-12°	0°	.120"	R	●	BTS-B8-327	BTS-B2-327
				L	●	BTS-B8-328	BTS-B2-328
5 5 2 nd Bicuspid	-17°	0°	.120"	R	●	BTS-B8-329R	BTS-B2-329R
				L	●	BTS-B8-329L	BTS-B2-329L
5 5 2 nd Bicuspid with offset	-17°	0°	.120"	R	●	BTS-B8-330R	BTS-B2-330R
				L	●	BTS-B8-330L	BTS-B2-330L
5 5 2 nd Bicuspid with hook	-17°	0°	.120"	R	●	BTS-B8-331	BTS-B2-331
				L	●	BTS-B8-332	BTS-B2-332
5 5 2 nd Bicuspid w/hook & offset	-17°	0°	.120"	R	●	BTS-B8-333	BTS-B2-333
				L	●	BTS-B8-334	BTS-B2-334
4/5 4/5 Bicuspid	0°	0°	.120"	R	●	BTS-B8-335R	BTS-B2-335R
				L	●	BTS-B8-335L	BTS-B2-335L
4/5 4/5 Bicuspid with hook	0°	0°	.120"	R	●	BTS-B8-336	BTS-B2-336
				L	●	BTS-B8-337	BTS-B2-337



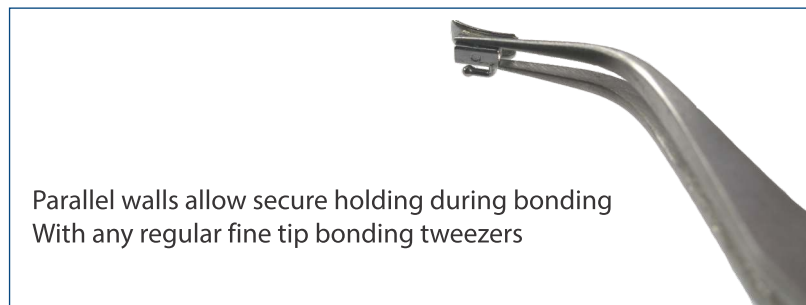
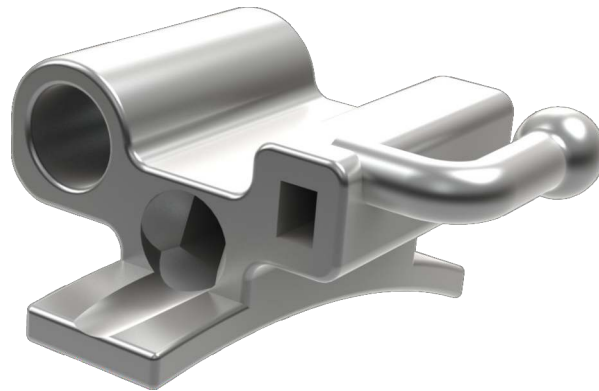
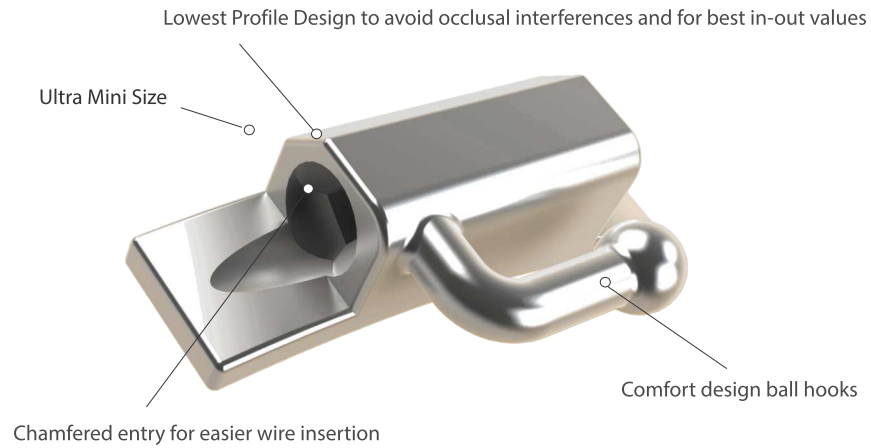
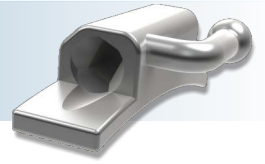

Lowest Profile | Funnel Entry
Metal Injection Molded | Comfort Hooks



Upper single 1st molar tubes

Slot Torque	Prescription	Slot Size	Weldable		Bondable	
			Left	Right	Left	Right
-10°	Roth	.018"	MT-8W-S03	MT-8W-S02	MT-8B-S03	MT-8B-S02
-10°	Roth	.022"	MT-2W-S03	MT-2W-S02	MT-2B-S03	MT-2B-S02
-14°	MBT	.018"	MT-8W-S05	MT-8W-S04	MT-8B-S05	MT-8B-S04
-14°	MBT	.022"	MT-2W-S05	MT-2W-S04	MT-2B-S05	MT-2B-S04
Round	BEGG	.036"	MT-6W-S22	MT-6W-S21	MT-6B-S22	MT-6B-S21



Lower single 1st molar tubes

Slot Torque	Prescription	Slot Size	Weldable		Bondable	
			Left	Right	Left	Right
-25°	Roth	.018"	MT-8W-S07	MT-8W-S06	MT-8B-S07	MT-8B-S06
-25°	Roth	.022"	MT-2W-S07	MT-2W-S06	MT-2B-S07	MT-2B-S06
-20°	MBT	.018"	MT-8W-S09	MT-8W-S08	MT-8B-S09	MT-8B-S08
-20°	MBT	.022"	MT-2W-S09	MT-2W-S08	MT-2B-S09	MT-2B-S08
-	BEGG	.036"	MT-6W-S24	MT-6W-S23	MT-6B-S24	MT-6B-S23



Upper single 2nd molar tubes

Slot Torque	Prescription	Slot Size	Weldable		Bondable	
			Left	Right	Left	Right
-10°	Roth	.018"	MT-8W-S23	MT-8W-S22	MT-8B-S23	MT-8B-S22
-10°	Roth	.022"	MT-2W-S23	MT-2W-S22	MT-2B-S23	MT-2B-S22
-14°	MBT	.018"	MT-8W-S25	MT-8W-S24	MT-8B-S25	MT-8B-S24
-14°	MBT	.022"	MT-2W-S25	MT-2W-S24	MT-2B-S25	MT-2B-S24



Lower single 2nd molar tubes

Slot Torque	Prescription	Slot Size	Weldable		Bondable	
			Left	Right	Left	Right
-25°	Roth	.018"	MT-8W-S27	MT-8W-S26	MT-8B-S27	MT-8B-S26
-25°	Roth	.022"	MT-2W-S27	MT-2W-S26	MT-2B-S27	MT-2B-S26
-10°	MBT	.018"	MT-8W-S29	MT-8W-S28	MT-8B-S29	MT-8B-S28
-10°	MBT	.022"	MT-2W-S29	MT-2W-S28	MT-2B-S29	MT-2B-S28



Upper double auxiliary tubes

.018"X.025" Auxiliary tube with 0° torque

Slot Torque	Prescription	Slot Size	Weldable		Bondable	
			Left	Right	Left	Right
-10°	Roth	.018"	MT-8W-D07	MT-8W-D06	MT-8B-D07	MT-8B-D06
-10°	Roth	.022"	MT-2W-D07	MT-2W-D06	MT-2B-D07	MT-2B-D06
-14°	MBT	.018"	MT-8W-D09	MT-8W-D08	MT-8B-D09	MT-8B-D08
-14°	MBT	.022"	MT-2W-D09	MT-2W-D08	MT-2B-D09	MT-2B-D08

Lower double lip bumper tubes

.045" Gingival lip bumper tube

Slot Torque	Prescription	Slot Size	Weldable		Bondable	
			Left	Right	Left	Right
-25°	Roth	.018"	MT-8W-D11	MT-8W-D10	MT-8B-D11	MT-8B-D10
-25°	Roth	.022"	MT-2W-D11	MT-2W-D10	MT-2B-D11	MT-2B-D10
-20°	MBT	.018"	MT-8W-D13	MT-8W-D12	MT-8B-D13	MT-8B-D12
-20°	MBT	.022"	MT-2W-D13	MT-2W-D12	MT-2B-D13	MT-2B-D12



Upper double headgear tubes

.045" Occlusal headgear tube

Slot Torque	Prescription	Slot Size	Weldable		Bondable	
			Left	Right	Left	Right
-10°	Roth	.018"	MT-8W-D03	MT-8W-D02	MT-8B-D03	MT-8B-D02
-10°	Roth	.022"	MT-2W-D03	MT-2W-D02	MT-2B-D03	MT-2B-D02
-14°	MBT	.018"	MT-8W-D05	MT-8W-D04	MT-8B-D05	MT-8B-D04
-14°	MBT	.022"	MT-2W-D05	MT-2W-D04	MT-2B-D05	MT-2B-D04



Lower double auxiliary tubes

.018"X.025" Auxiliary tube with 0° torque

Slot Torque	Prescription	Slot Size	Weldable		Bondable	
			Left	Right	Left	Right
-25°	Roth	.018"	MT-8W-D15	MT-8W-D14	MT-8B-D15	MT-8B-D14
-25°	Roth	.022"	MT-2W-D15	MT-2W-D14	MT-2B-D15	MT-2B-D14
-20°	MBT	.018"	MT-8W-D17	MT-8W-D16	MT-8B-D17	MT-8B-D16
-20°	MBT	.022"	MT-2W-D17	MT-2W-D16	MT-2B-D17	MT-2B-D16

Upper triple tubes

.018"X.025" Auxiliary tube with 0° torque

.045" Occlusal headgear tube

Slot Torque	Prescription	Slot Size	Weldable		Bondable	
			Left	Right	Left	Right
-10°	Roth	.018"	MT-8W-T03	MT-8W-T02	MT-8B-T03	MT-8B-T02
-10°	Roth	.022"	MT-2W-T03	MT-2W-T02	MT-2B-T03	MT-2B-T02
-14°	MBT	.018"	MT-8W-T05	MT-8W-T04	MT-8B-T05	MT-8B-T04
-14°	MBT	.022"	MT-2W-T05	MT-2W-T04	MT-2B-T05	MT-2B-T04



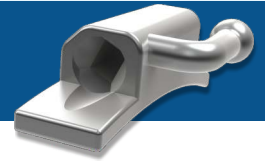

5 patient pack Roth .018" 1st molar tubes

Prescription	Slot Size	Weldable		Cat. No.	Slot Size	Bondable		Cat. No.
		Upper	Lower			Upper	Lower	
Roth	.018"	Single	Single	MT-8W-K01	.018"	Single	Single	MT-8B-K01
Roth	.018"	Double Headgear	Single	MT-8W-K02	.018"	Double Headgear	Single	MT-8B-K02
Roth	.018"	Double Auxillary	Single	MT-8W-K03	.018"	Double Auxillary	Single	MT-8B-K03
Roth	.018"	Triple	Double Auxillary	MT-8W-K04	.018"	Triple	Double Auxillary	MT-8B-K04
Roth	.018"	Triple	Double Lip-bumper	MT-8W-K05	.018"	Triple	Double Lipbumper	MT-8B-K05



5 patient pack Roth .022" 1st molar tubes

Prescription	Slot Size	Weldable		Cat. No.	Slot Size	Bondable		Cat. No.
		Upper	Lower			Upper	Lower	
Roth	.022"	Single	Single	MT-2W-K01	.022"	Single	Single	MT-2B-K01
Roth	.022"	Double Headgear	Single	MT-2W-K02	.022"	Double Headgear	Single	MT-2B-K02
Roth	.022"	Double Auxillary	Single	MT-2W-K03	.022"	Double Auxillary	Single	MT-2B-K03
Roth	.022"	Triple	Double Auxillary	MT-2W-K04	.022"	Triple	Double Auxillary	MT-2B-K04
Roth	.022"	Triple	Double Lip-bumper	MT-2W-K05	.022"	Triple	Double Lipbumper	MT-2B-K05



5 patient pack MBT .018" 1st molar tubes

Prescription	Slot Size	Weldable		Cat. No.	Slot Size	Bondable		Cat. No.
		Upper	Lower			Upper	Lower	
MBT	.018"	Single	Single	MT-8W-K11	.018"	Single	Single	MT-8B-K11
MBT	.018"	Double Headgear	Single	MT-8W-K12	.018"	Double Headgear	Single	MT-8B-K12
MBT	.018"	Double Auxillary	Single	MT-8W-K13	.018"	Double Auxillary	Single	MT-8B-K13
MBT	.018"	Triple	Double Auxillary	MT-8W-K14	.018"	Triple	Double Auxillary	MT-8B-K14
MBT	.018"	Triple	Double Lip-bumper	MT-8W-K15	.018"	Triple	Double Lipbumper	MT-8B-K15



5 patient pack MBT .022" 1st molar tubes

Prescription	Slot Size	Weldable		Cat. No.	Slot Size	Bondable		Cat. No.
		Upper	Lower			Upper	Lower	
MBT	.022"	Single	Single	MT-2W-K11	.022"	Single	Single	MT-2B-K11
MBT	.022"	Double Headgear	Single	MT-2W-K12	.022"	Double Headgear	Single	MT-2B-K12
MBT	.022"	Double Auxillary	Single	MT-2W-K13	.022"	Double Auxillary	Single	MT-2B-K13
MBT	.022"	Triple	Double Auxillary	MT-2W-K14	.022"	Triple	Double Auxillary	MT-2B-K14
MBT	.022"	Triple	Double Lipbumper	MT-2W-K15	.022"	Triple	Double Lipbumper	MT-2B-K15



5 patient pack 2nd molar tubes

Prescription	Slot Size	Weldable		Cat. No.	Slot Size	Bondable		Cat. No.
		Upper	Lower			Upper	Lower	
Roth	.018"	Single	Single	MT-8W-K21	.018"	Single	Single	MT-8B-K21
Roth	.022"	Single	Single	MT-2W-K21	.022"	Single	Single	MT-2B-K21
MBT	.018"	Single	Single	MT-8W-K22	.018"	Single	Single	MT-8B-K22
MBT	.022"	Single	Single	MT-2W-K22	.022"	Single	Single	MT-2B-K22

Chamfered entry for easier wire insertion

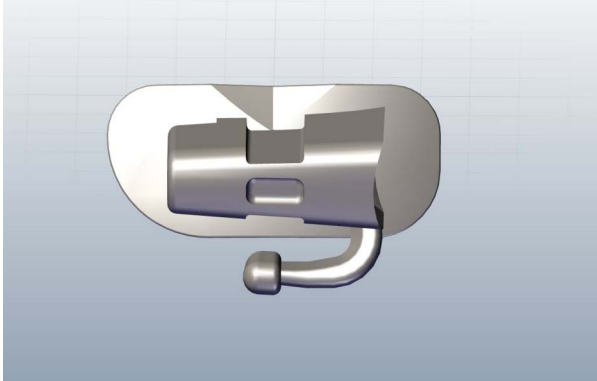

Comfort design ball hooks

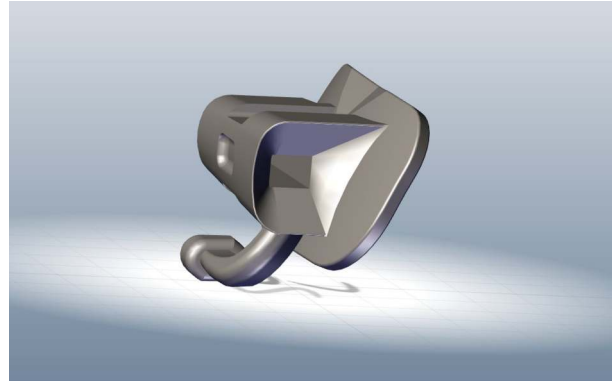

Lowest Profile Design to avoid occlusal interferences and for best in-out values

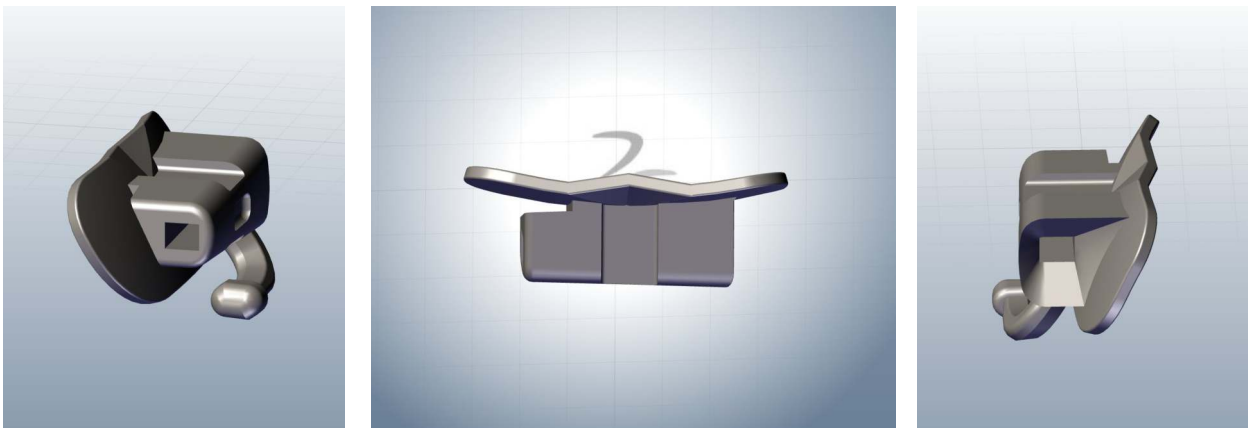

Allows secure holding during bonding with any regular fine tip bonding tweezers

Distal Notch for engagement of elastomerics or ligatures

80G Mesh pad with proven bonding strength and buccal notch

Lowest Profile | **Funnel Entry**
Metal Injection Molded | **Comfort Hooks**



Upper single 1st molar tubes

Slot Torque	Prescription	Slot Size	Bondable	
			Left	Right
-10°	Roth	.018"	MA-8B-S03	MA-8B-S02
-10°	Roth	.022"	MA-2B-S03	MA-2B-S02
-14°	MBT	.018"	MA-8B-S05	MA-8B-S04
-14°	MBT	.022"	MA-2B-S05	MA-2B-S04

Upper single 2nd molar tubes

Slot Torque	Prescription	Slot Size	Bondable	
			Left	Right
-10°	Roth	.018"	MA-8B-S23	MA-8B-S22
-10°	Roth	.022"	MA-2B-S23	MA-2B-S22
-14°	MBT	.018"	MA-8B-S25	MA-8B-S24
-14°	MBT	.022"	MA-2B-S25	MA-2B-S24

Lower single 1st molar tubes

Slot Torque	Prescription	Slot Size	Bondable	
			Left	Right
-25°	Roth	.018"	MA-8B-S07	MA-8B-S06
-25°	Roth	.022"	MA-2B-S07	MA-2B-S06
-20°	MBT	.018"	MA-8B-S09	MA-8B-S08
-20°	MBT	.022"	MA-2B-S09	MA-2B-S08

Lower single 2nd molar tubes

Slot Torque	Prescription	Slot Size	Bondable	
			Left	Right
-25°	Roth	.018"	MA-8B-S27	MA-8B-S26
-25°	Roth	.022"	MA-2B-S27	MA-2B-S26
-10°	MBT	.018"	MA-8B-S29	MA-8B-S28
-10°	MBT	.022"	MA-2B-S29	MA-2B-S28

5 patient pack 1st molar tubes

Prescription	Slot Size	Bondable		Cat. No.
		Upper	Lower	
Roth	.018"	Single	Single	MA-8B-K01
Roth	.022"	Single	Single	MA-2B-K01
MBT	.018"	Single	Single	MA-8B-K11
MBT	.022"	Single	Single	MA-2B-K11

5 patient pack 2nd molar tubes

Prescription	Slot Size	Bondable		Cat. No.
		Upper	Lower	
Roth	.018"	Single	Single	MA-8B-K21
Roth	.022"	Single	Single	MA-2B-K21
MBT	.018"	Single	Single	MA-8B-K22
MBT	.022"	Single	Single	MA-2B-K22



Micro-Etched Interior Surface

Ensures maximum retention

Straight Interproximal Wall

Makes band seating easy

Ideally Tempered

For easy contouring



Rolled Edges

No sharp edges maximum patient comfort

Anatomically Contoured

Fast, placement and accurate fit

Permanent Marking

For easy identification

Pre-welded 1st Molar band Kits With .018" MBT Molar Tubes. 400 Bands (100/Quadrant) (No Lingual Attachments)

Prescription	Slot Size	Upper Molar Tubes	Lower Molar Tubes	Catalog No.
MBT	.018"	Single	Single	AUK-8M-K01
MBT	.018"	Double Headgear	Single	AUK-8M-K02
MBT	.018"	Double Auxillary	Single	AUK-8M-K03
MBT	.018"	Triple	Double Auxillary	AUK-8M-K04
MBT	.018"	Triple	Double Lip-bumper	AUK-8M-K05

(No Lingual Attachments)

Pre-welded 1st Molar band Kits With .022" MBT Molar Tubes. 400 Bands (100/Quadrant) (No Lingual Attachments)

Prescription	Slot Size	Upper Molar Tubes	Lower Molar Tubes	Catalog No.
MBT	.022"	Single	Single	AUK-2M-K01
MBT	.022"	Double Headgear	Single	AUK-2M-K02
MBT	.022"	Double Auxillary	Single	AUK-2M-K03
MBT	.022"	Triple	Double Auxillary	AUK-2M-K04
MBT	.022"	Triple	Double Lip-bumper	AUK-2M-K05

Pre-welded 1st Molar band Kits With .018" Roth Molar Tubes. 400 Bands (100/Quadrant) (No Lingual Attachments)

Prescription	Slot Size	Upper Molar Tubes	Lower Molar Tubes	Catalog No.
Roth	.018"	Single	Single	AUK-8R-K01
Roth	.018"	Double Headgear	Single	AUK-8R-K02
Roth	.018"	Double Auxillary	Single	AUK-8R-K03
Roth	.018"	Triple	Double Auxillary	AUK-8R-K04
Roth	.018"	Triple	Double Lip-bumper	AUK-8R-K05

Pre-welded 1st Molar band Kits With .022" Roth Molar Tubes. 400 Bands (100/Quadrant) (No Lingual Attachments)

Prescription	Slot Size	Upper Molar Tubes	Lower Molar Tubes	Catalog No.
Roth	.022"	Single	Single	AUK-2R-K01
Roth	.022"	Double Headgear	Single	AUK-2R-K02
Roth	.022"	Double Auxillary	Single	AUK-2R-K03
Roth	.022"	Triple	Double Auxillary	AUK-2R-K04
Roth	.022"	Triple	Double Lip-bumper	AUK-2R-K05

Plain Band Kit 400 1st Molar bands 100/Quadrant AUK-400-FP

* All bands kits with lingual attachment can be ordered as custom order using our "Bands order Form"



Sturdy box packaging



All four quadrants bands in one box



Maxillary and Mandibular 1st Molar Plain Bands catalog numbers

Size	Upper Right	Upper Left	Lower Right	Lower Left
29.5	AUR29-5UP	AUL29-5UP	ALR29-5FP	ALL29-5FP
30	AUR30-0UP	AUL30-0UP	ALR30-0FP	ALL30-0FP
30.5	AUR30-5UP	AUL30-5UP	ALR30-5FP	ALL30-5FP
31	AUR31-0UP	AUL31-0UP	ALR31-0FP	ALL31-0FP
31.5	AUR31-5UP	AUL31-5UP	ALR31-5FP	ALL31-5FP
32	AUR32-0UP	AUL32-0UP	ALR32-0FP	ALL32-0FP
32.5	AUR32-5UP	AUL32-5UP	ALR32-5FP	ALL32-5FP
33	AUR33-0UP	AUL33-0UP	ALR33-0FP	ALL33-0FP
33.5	AUR33-5UP	AUL33-5UP	ALR33-5FP	ALL33-5FP
34	AUR34-0UP	AUL34-0UP	ALR34-0FP	ALL34-0FP
34.5	AUR34-5UP	AUL34-5UP	ALR34-5FP	ALL34-5FP
35	AUR35-0UP	AUL35-0UP	ALR35-0FP	ALL35-0FP
35.5	AUR35-5UP	AUL35-5UP	ALR35-5FP	ALL35-5FP
36	AUR36-0UP	AUL36-0UP	ALR36-0FP	ALL36-0FP
36.5	AUR36-5UP	AUL36-5UP	ALR36-5FP	ALL36-5FP
37	AUR37-0UP	AUL37-0UP	ALR37-0FP	ALL37-0FP
37.5	AUR37-5UP	AUL37-5UP	ALR37-5FP	ALL37-5FP
38	AUR38-0UP	AUL38-0UP	ALR38-0FP	ALL38-0FP
38.5	AUR38-5UP	AUL38-5UP	ALR38-5FP	ALL38-5FP
39	AUR39-0UP	AUL39-0UP	ALR39-0FP	ALL39-0FP
39.5	AUR39-5UP	AUL39-5UP	ALR39-5FP	ALL39-5FP
40	AUR40-0UP	AUL40-0UP	ALR40-0FP	ALL40-0FP
40.5	AUR40-5UP	AUL40-5UP	ALR40-5FP	ALL40-5FP
41	AUR41-0UP	AUL41-0UP	ALR41-0FP	ALL41-0FP
41.5	AUR41-5UP	AUL41-5UP	ALR41-5FP	ALL41-5FP
42	AUR42-0UP	AUL42-0UP	ALR42-0FP	ALL42-0FP
42.5	AUR42-5UP	AUL42-5UP	ALR42-5FP	ALL42-5FP
43	AUR43-0UP	AUL43-0UP	ALR43-0FP	ALL43-0FP
43.5	AUR43-5UP	AUL43-5UP	ALR43-5FP	ALL43-5FP

Distribution chart of Pre-welded Molar Bands kits. 400 Bands(100/Quadrant)

Bands In One Quadrant		29.5	30	30.5	31	31.5	32	32.5	33	33.5	34	34.5	35	35.5	36	36.5	37	37.5	38	38.5	39	39.5	40	40.5	41	41.5	42	42.5	43	43.5
UL	100 Pc	2	2	2	2	2	2	2	2	4	4	4	6	8	8	8	6	6	4	4	4	2	2	2	2	2	2	2	2	2
UR	100 Pc	2	2	2	2	2	2	2	2	4	4	4	6	8	8	8	6	6	4	4	4	2	2	2	2	2	2	2	2	2
LL	100 Pc	2	2	2	2	2	2	2	2	4	4	4	6	8	8	8	6	6	4	4	4	2	2	2	2	2	2	2	2	2
LR	100 Pc	2	2	2	2	2	2	2	2	4	4	4	6	8	8	8	6	6	4	4	4	2	2	2	2	2	2	2	2	2

Ideally Tempered
Laser Marking
Internally Sand Blasted
Rolled Edges

Available Plain or Prewelded



Standard Preweld Position

Buccal Attachments to Molar Bands

The main archwire slot is centered occlusal/gingivally, and the hook is always placed towards the gingiva.

Standard angulation is always 0°, which means the main slot runs parallel with the occlusal margin of the band.

The mesial face of the tube bisects the buccal cusp on the maxillary arch, while on the mandibular arch the main body of the tube is centered on the buccal indent.

Lingual Attachments to Molar Bands

Standard positioning for lingual attachments are as follows for each attachment:

Lingual Sheaths and Cleats are centered mesial/distal as well as occlusal/gingival.

Buttons are centered on the mesial cusp and are offset 1mm towards the occlusal margin from the center of the band.

We offer standard and custom pre-welding services to meet all your practice needs. Using the chart below, choose the position of pre-welds that suits your practice needs.

Step 1: Choose Your Mesial / Distal Positioning

Upper Molar

Lower Molar

1/3 Mesial

Two millimeters of forward (mesial) placement of the buccal tube on the band will add approximately 10 degrees of distal offset.



1/3 Mesial



Standard

The standard welding position is designed to deliver the distal offset manufactured into the buccal tube.



Standard



1/3 Distal

Two millimeters of backward (distal) placement of the buccal tube on the band will subtract approximately 10 degrees of distal offset.



1/3 Distal



Step 2: Choose Your Height Placement

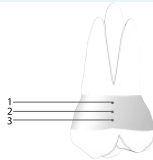

Uppers

Archwire Location

1 = 1/3 Gingival

2 = Standard

3 = 1/3 Occlusal

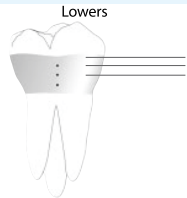

Lower



Premium Crimpable Hooks

17-4 Alloy for harder-tighter grip
Internally serrated to avoid slippage

Cat.no. CRH-001

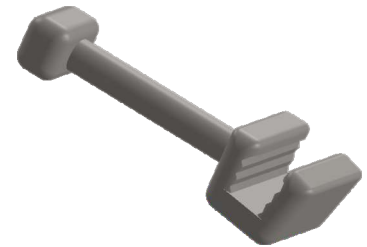

Prewelded Lingual Attachments for Molar Bands



Weldable Lingual Button
Cat.no. ALU-LB-001



Prewelded Sheath



Prewelded Cleat

Bondable
Lingual
Cleat



Cat.no. ALU-LC-002

10 per pack

Lingual
Sheaths



Cat.no. ALU-LS-001

10 per pack

Weldable
Lingual
Cleat



Cat.no. ALU-LC-001

10 per pack

Direct Bond
Lingual Buttons
Round Base



Cat.no. ALU-LB-002

10 per pack



Comparison Chart for Upgradation

Upper First Molar Bands														Lower First Molar Bands														
Modern Orthodontics	AA Company	American Cont. Master	Dentaurum	GAC Shapfit	Lancer Supra	Ormo Mark II	Ormo Standard	Ormo Ultima	Ormo Washbon	RMO Trufurm	TP	Unitek Victory Std.	Ortho Org. Tempira	Modern Orthodontics	AA Company	American Cont. Master	Dentaurum	GAC Shapfit	Lancer Supra	Ormo Mark II	Ormo Original	Ormo Ultima	Ormo Washbon	RMO Trufurm	TP	Unitek Victory Std.	Ortho Org. Tempira	
29.5			2	2								29	29	29.5			3		29.5							29.5	29.5	
	1		3						1								4		2			1			6			
30	2		4			2	2			6	00			30	1		5		30			2			00	30	30	
30.5	3		5	4	30.5	3	3		2	7		0	30.5	30.5			6		3		2		1					
			6			4	4		3					30.5	2		7		30.5	3	3		2		0	30.5	30.5	
31	4		7			5	5	5		8					3			4						8				
31.5	5		7		31	6	6	6	4	9	1	31	31	31	4	1.5	9		31	5	5		3		1	31	31	
31.5	6			5		6	7	7	5		2			31.5	5		10	5	31.5	6	6	5	4		2			
32	7	1.5	8		31.5	7	8		6		3	32	32	31.5		2	11	6	31.5	7	7	7		10		31.5	31.5	
32.5	8		10	6	32.5	9	9			11	5	32.5	32.5	32	7		12			8	8		6		4			
33	9	2.5	11		33	10	10	10	8		6	33	33	32		2.5			32	8		8	7		5	32	32	
		3	12			10	11	11	9		7				8		13	7			9	9		6				
34		3.5	13		34	12	12	12		13	9	34	34	33		3			33		11	10	9		8	33	33	
	11					13	13				10				10		15	8			10	10	10	12				
34.5	12	4	14	8	34.5	13	14	14	11	14	11	34.5	34.5				16			11	12	11			9			
	13		15			14	15		12	15	12			33.5	11	3.5			33.5		13	12		13	10	33.5	33.5	
35	14	4.5	16	9	35			15	13	16	13	35	35	34	12		17	9	34	12	14	13	11	14	11	34	34	
35.5	15	5	17	10	35.5	16		16	14	17	14	35.5	35.5	34.5	14	4	18	10	34.5	14	14	14	13	15	12	34.5	34.5	
				11			17	17	15	18	15			35		4.5	19			35	15	16	15		16	13	35	35
36	16	5.5	18	12	36	17			16		16	36	36		15			11					14		14			
	17					18	18	18		19	17			35.5		5	20	12	35.5		16	17	16	15	17	15	35.5	35.5
		6	19	13				19	17		18				16		21			17	17	17	16		16			
36.5	18		20	14	36.5	19	19	20		20	19	36.5	36.5		17			13			18	18		18	17			
37	19	6.5	21		37	20	20	21	18	21	20	37	37	36			22	14	36	18		17	17	18	18	36	36	
	20			15		20	20	21		22	21				18	6	23	15			19	19		19	19			
37.5		7	22	16	37.5			22	19	23	22	37.5	37.5	36.5		6.5			36.5	19			18	20	20	36.5	36.5	
						21	21			24					19	7	24	16			20	20	20		21	21		
			23	17			22		20	25	23			37			25	17	37			21	19	22		37	37	
38	21	7.5	24	18	38	22	23	23	21	26	24	38	38		20	7.5	26			21	21	22		23	22			
	22		25			23		22	22	27	25			37.5			27	18	37.5		22		20	24		37.5	37.5	
38.5	23	8	26	19	38.5		24	24		28	26	38.5	38.5		21		28	19		22	23	23	21	25	23			
39	24	9	27	21	39	24	25		24	29	27	39	39	38	22	8	29		38	23		24	22	26	24	38	38	
39.5	25		28	22	39.5			26	26	30	29	39.5	39.5		23		30	20		24	24		27	25				
		9.5	29			26	27	27	27	31	30			38.5	24				38.5		25	26	24	28	27	38.5	38.5	
	26		30	23		27	28	28		32	31			39		8.5		22	39	26	26		25	29	28	39	39	
40		10		24	40			29	28			40	40	39.5	25		31	23	39.5			27	26	30	29	39.5	39.5	
40.5	27	10.5	31		40.5	28	29			33	32	40.5	40.5		26	9.5		32			27	27	27	31	30			
	29		32	26		29		31	29	34				40	26		24	40			28	28		32	31	40	40	
41		11			41	30	30	32	30		33	41	41		27					29	29	30	28					
41.5	30	11.5		28	41.5	32	31		31	35	34	41.5	41.5	40.5	28	10.5		26	40.5	30		31		33	32	40.5	40.5	
42				29	42			33		36		42	42		29			27		31			34					
42.5		12			42.5		32		32		35	42.5	42.5	41		11			41		30	32	30		33	41	41	
43		12.5		30	43			34			36	43	43	41.5		11.5		28	41.5		31	31	35	34	41.5	41.5		
43.5		13		31	43.5			35				43.5	43.5	42			29	42			33		36		42	42		
		13.5		32	44			36				44	44	42.5		12			42.5		32		32		35	42.5	42.5	
														43		12.5		30	43			34			36	43	43	
														43.5		13		31	43.5			35				43.5	43.5	
															13.5		32	44				36				44	44	

(Modern Orthodontics is not responsible for the accuracy of this information.)

TiNo1™ Nickel Titanium?

Modern Orthodontic's TiNo1™ Nickel Titanium wire is the result of years of **research and advancement** in several key areas of the material science over the period of years.

TiNo1™ is made possible by the **vast experience and expertise** that MO has developed in working with nitinol and controlling its properties. Our Nitinol shop staff has a combined experience of more than 18 years.

Nickel Titanium is an alloy which is complex to process and form. Very slight variations in a multitude of factors during manufacturing can alter the clinical performance of NiTi wires. MO has worked hard to achieve **consistent force, elasticity and memory** of each wire.

The TiNo1™ manufacturing processes some invented, some developed and others refined by MO make TiNo1™ NiTi **distinct** from all other NiTi archwires used in Orthodontics.

Only scientific testing of a NiTi wire can determine its actual working characteristics. TiNo1™ NiTi archwires undergo intense scientific testing during the manufacturing process Every TiNo1™ wire undergoes a **100% final inspection** before packaging.

TiNo1™ wire provide lower initial load forces and increased residual forces as full shape recovery progresses. **Lower Loading Forces** of Engagement result in easier wire deflection and delivery to bracket, less stress on bonds and **increased patient comfort**. Higher Residual Forces of Recovery gives full shape recovery, complete unraveling and archform development by staying active to the end

Tooth Friendly Forces

Laser Marked Midline

Diamond Polished

Kink Resistant

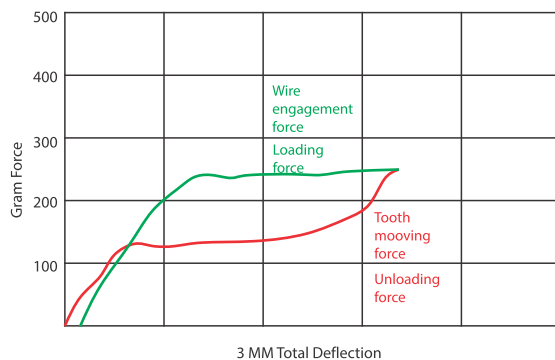

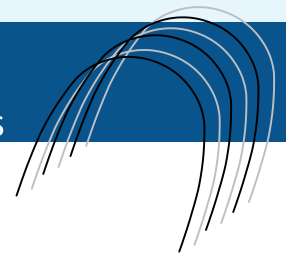

TiNol-1™ Super Elastic Nitinol

Super elastic nitinol is by far the volume leader for NiTi wires in the orthodontics.

TiNol™ is fully austenitic at room temperature and the force of the wire will not change once placed in the mouth.

TiNol™ works extremely well when the teeth are not severely mal-aligned.

TiNol™ is the wire of choice for doctors that want the stronger, stiffer nickel titanium wire which produce quick initial alignment of teeth.

The loading and unloading forces exerted by TiNol™ arch-wires are more compared to heat activated or thermal shape memory wires.

TiNol™ is also more resistant to permanent deformation.

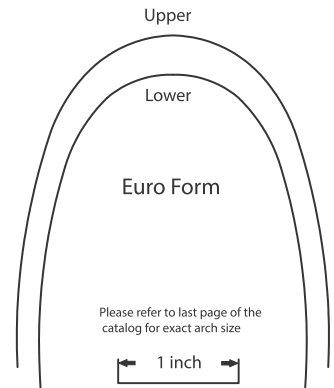
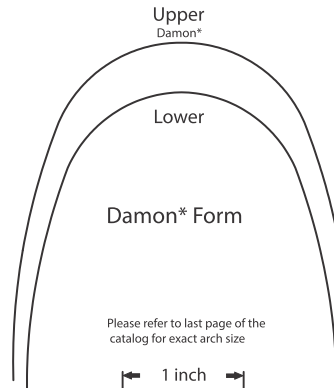
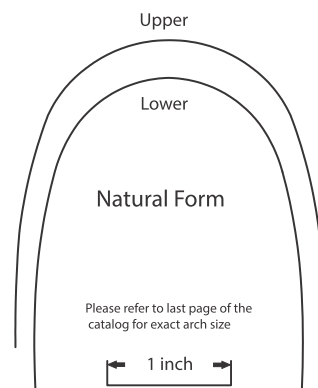
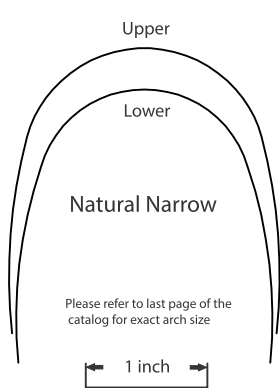
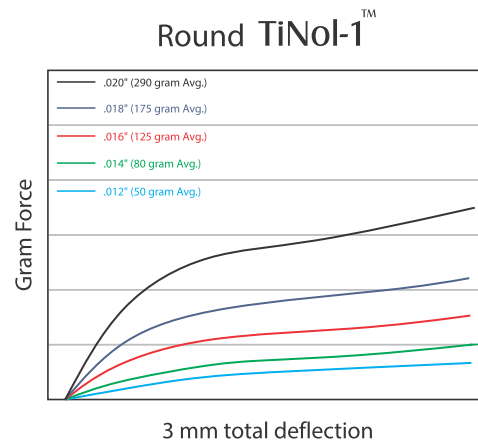
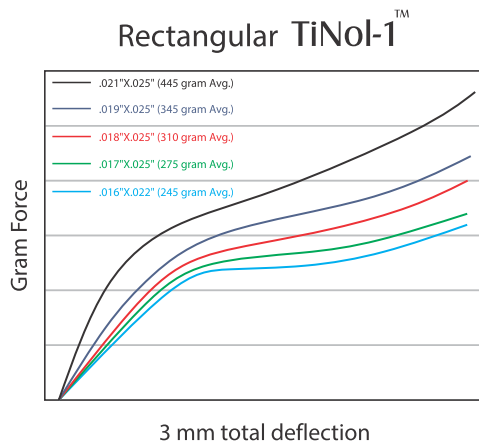

*MO wire is in no way affiliated with or endorsed by Ormco Corporation or Dr. Dwight Damon



Solo Pk of 10

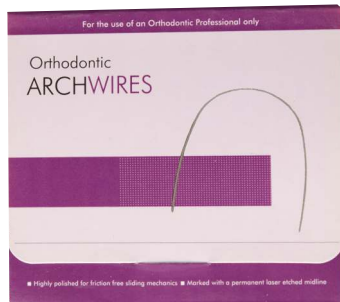

Box Pk of 10



Econo Pk of 50

TiNol-1™ Super Elastic **Natural Narrow** Solo Pk of 10

● Round	▲ Upper	▼ Lower
.012"	NTS12U-NNESE	NTS12L-NNESE
.014"	NTS14U-NNESE	NTS14L-NNESE
.016"	NTS16U-NNESE	NTS16L-NNESE
.018"	NTS18U-NNESE	NTS18L-NNESE
.020"	NTS20U-NNESE	NTS20L-NNESE

● Rectangle	▲ Upper	▼ Lower
.016" X .016"	NTS1616U-NNESE	NTS1616L-NNESE
.016" X .022"	NTS1622U-NNESE	NTS1622L-NNESE
.017" X .025"	NTS1725U-NNESE	NTS1725L-NNESE
.018" X .018"	NTS1818U-NNESE	NTS1818L-NNESE
.018" X .025"	NTS1825U-NNESE	NTS1825L-NNESE
.019" X .025"	NTS1925U-NNESE	NTS1925L-NNESE
.021" X .025"	NTS2125U-NNESE	NTS2125L-NNESE

TiNol-1™ Super Elastic **Natural Narrow** Box Pk of 10

● Round	▲ Upper	▼ Lower
.012"	NTB12U-NNESE	NTB12L-NNESE
.014"	NTB14U-NNESE	NTB14L-NNESE
.016"	NTB16U-NNESE	NTB16L-NNESE
.018"	NTB18U-NNESE	NTB18L-NNESE
.020"	NTB20U-NNESE	NTB20L-NNESE

● Rectangle	▲ Upper	▼ Lower
.016" X .016"	NTB1616U-NNESE	NTB1616L-NNESE
.016" X .022"	NTB1622U-NNESE	NTB1622L-NNESE
.017" X .025"	NTB1725U-NNESE	NTB1725L-NNESE
.018" X .018"	NTB1818U-NNESE	NTB1818L-NNESE
.018" X .025"	NTB1825U-NNESE	NTB1825L-NNESE
.019" X .025"	NTB1925U-NNESE	NTB1925L-NNESE
.021" X .025"	NTB2125U-NNESE	NTB2125L-NNESE

TiNol-1™ Super Elastic **Natural Narrow** Econo Pk of 50

● Round	▲ Upper	▼ Lower
.012"	NTE12U-NNESE	NTE12L-NNESE
.014"	NTE14U-NNESE	NTE14L-NNESE
.016"	NTE16U-NNESE	NTE16L-NNESE
.018"	NTE18U-NNESE	NTE18L-NNESE
.020"	NTE20U-NNESE	NTE20L-NNESE

● Rectangle	▲ Upper	▼ Lower
.016" X .016"	NTE1616U-NNESE	NTE1616L-NNESE
.016" X .022"	NTE1622U-NNESE	NTE1622L-NNESE
.017" X .025"	NTE1725U-NNESE	NTE1725L-NNESE
.018" X .018"	NTE1818U-NNESE	NTE1818L-NNESE
.018" X .025"	NTE1825U-NNESE	NTE1825L-NNESE
.019" X .025"	NTE1925U-NNESE	NTE1925L-NNESE
.021" X .025"	NTE2125U-NNESE	NTE2125L-NNESE

TiNol-1™ Super Elastic **Natural Form** Solo Pk of 10

● Round	▲ Upper	▼ Lower
.012"	NTS12U-NFESE	NTS12L-NFESE
.014"	NTS14U-NFESE	NTS14L-NFESE
.016"	NTS16U-NFESE	NTS16L-NFESE
.018"	NTS18U-NFESE	NTS18L-NFESE
.020"	NTS20U-NFESE	NTS20L-NFESE

● Rectangle	▲ Upper	▼ Lower
.016" X .016"	NTS1616U-NFESE	NTS1616L-NFESE
.016" X .022"	NTS1622U-NFESE	NTS1622L-NFESE
.017" X .025"	NTS1725U-NFESE	NTS1725L-NFESE
.018" X .018"	NTS1818U-NFESE	NTS1818L-NFESE
.018" X .025"	NTS1825U-NFESE	NTS1825L-NFESE
.019" X .025"	NTS1925U-NFESE	NTS1925L-NFESE
.021" X .025"	NTS2125U-NFESE	NTS2125L-NFESE

TiNol-1™ Super Elastic **Natural Form** Box Pk of 10

● Round	▲ Upper	▼ Lower
.012"	NTB12U-NFESE	NTB12L-NFESE
.014"	NTB14U-NFESE	NTB14L-NFESE
.016"	NTB16U-NFESE	NTB16L-NFESE
.018"	NTB18U-NFESE	NTB18L-NFESE
.020"	NTB20U-NFESE	NTB20L-NFESE

● Rectangle	▲ Upper	▼ Lower
.016" X .016"	NTB1616U-NFESE	NTB1616L-NFESE
.016" X .022"	NTB1622U-NFESE	NTB1622L-NFESE
.017" X .025"	NTB1725U-NFESE	NTB1725L-NFESE
.018" X .018"	NTB1818U-NFESE	NTB1818L-NFESE
.018" X .025"	NTB1825U-NFESE	NTB1825L-NFESE
.019" X .025"	NTB1925U-NFESE	NTB1925L-NFESE
.021" X .025"	NTB2125U-NFESE	NTB2125L-NFESE

TiNol-1™ Super Elastic **Natural Form** Econo Pk of 50

● Round	▲ Upper	▼ Lower
.012"	NTE12U-NFESE	NTE12L-NFESE
.014"	NTE14U-NFESE	NTE14L-NFESE
.016"	NTE16U-NFESE	NTE16L-NFESE
.018"	NTE18U-NFESE	NTE18L-NFESE
.020"	NTE20U-NFESE	NTE20L-NFESE

● Rectangle	▲ Upper	▼ Lower
.016" X .016"	NTE1616U-NFESE	NTE1616L-NFESE
.016" X .022"	NTE1622U-NFESE	NTE1622L-NFESE
.017" X .025"	NTE1725U-NFESE	NTE1725L-NFESE
.018" X .018"	NTE1818U-NFESE	NTE1818L-NFESE
.018" X .025"	NTE1825U-NFESE	NTE1825L-NFESE
.019" X .025"	NTE1925U-NFESE	NTE1925L-NFESE
.021" X .025"	NTE2125U-NFESE	NTE2125L-NFESE

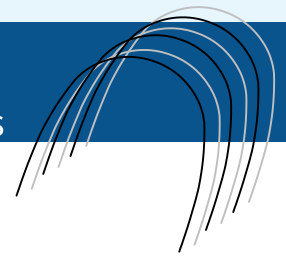

TiNol-1™ Super Elastic *Damon Form Solo Pk of 10

● Round	▲ Upper	▼ Lower
.012"	NTS12U-DFESE	NTS12L-DFESE
.014"	NTS14U-DFESE	NTS14L-DFESE
.016"	NTS16U-DFESE	NTS16L-DFESE
.018"	NTS18U-DFESE	NTS18L-DFESE
.020"	NTS20U-DFESE	NTS20L-DFESE

● Rectangle	▲ Upper	▼ Lower
.016" X .016"	NTS1616U-DFESE	NTS1616L-DFESE
.016" X .022"	NTS1622U-DFESE	NTS1622L-DFESE
.017" X .025"	NTS1725U-DFESE	NTS1725L-DFESE
.018" X .018"	NTS1818U-DFESE	NTS1818L-DFESE
.018" X .025"	NTS1825U-DFESE	NTS1825L-DFESE
.019" X .025"	NTS1925U-DFESE	NTS1925L-DFESE
.021" X .025"	NTS2125U-DFESE	NTS2125L-DFESE

TiNol-1™ Super Elastic *Damon Form Box Pk of 10

● Round	▲ Upper	▼ Lower
.012"	NTB12U-DFESE	NTB12L-DFESE
.014"	NTB14U-DFESE	NTB14L-DFESE
.016"	NTB16U-DFESE	NTB16L-DFESE
.018"	NTB18U-DFESE	NTB18L-DFESE
.020"	NTB20U-DFESE	NTB20L-DFESE

● Rectangle	▲ Upper	▼ Lower
.016" X .016"	NTB1616U-DFESE	NTB1616L-DFESE
.016" X .022"	NTB1622U-DFESE	NTB1622L-DFESE
.017" X .025"	NTB1725U-DFESE	NTB1725L-DFESE
.018" X .018"	NTB1818U-DFESE	NTB1818L-DFESE
.018" X .025"	NTB1825U-DFESE	NTB1825L-DFESE
.019" X .025"	NTB1925U-DFESE	NTB1925L-DFESE
.021" X .025"	NTB2125U-DFESE	NTB2125L-DFESE

TiNol-1™ Super Elastic *Damon Form Econo Pk of 50

● Round	▲ Upper	▼ Lower
.012"	NTE12U-DFESE	NTE12L-DFESE
.014"	NTE14U-DFESE	NTE14L-DFESE
.016"	NTE16U-DFESE	NTE16L-DFESE
.018"	NTE18U-DFESE	NTE18L-DFESE
.020"	NTE20U-DFESE	NTE20L-DFESE

● Rectangle	▲ Upper	▼ Lower
.016" X .016"	NTE1616U-DFESE	NTE1616L-DFESE
.016" X .022"	NTE1622U-DFESE	NTE1622L-DFESE
.017" X .025"	NTE1725U-DFESE	NTE1725L-DFESE
.018" X .018"	NTE1818U-DFESE	NTE1818L-DFESE
.018" X .025"	NTE1825U-DFESE	NTE1825L-DFESE
.019" X .025"	NTE1925U-DFESE	NTE1925L-DFESE
.021" X .025"	NTE2125U-DFESE	NTE2125L-DFESE

TiNol-1™ Super Elastic Euro Form Solo Pk of 10

● Round	▲ Upper	▼ Lower
.012"	NTS12U-EFESE	NTS12L-EFESE
.014"	NTS14U-EFESE	NTS14L-EFESE
.016"	NTS16U-EFESE	NTS16L-EFESE
.018"	NTS18U-EFESE	NTS18L-EFESE
.020"	NTS20U-EFESE	NTS20L-EFESE

● Rectangle	▲ Upper	▼ Lower
.016" X .016"	NTS1616U-EFESE	NTS1616L-EFESE
.016" X .022"	NTS1622U-EFESE	NTS1622L-EFESE
.017" X .025"	NTS1725U-EFESE	NTS1725L-EFESE
.018" X .018"	NTS1818U-EFESE	NTS1818L-EFESE
.018" X .025"	NTS1825U-EFESE	NTS1825L-EFESE
.019" X .025"	NTS1925U-EFESE	NTS1925L-EFESE
.021" X .025"	NTS2125U-EFESE	NTS2125L-EFESE

TiNol-1™ Super Elastic Euro Form Box Pk of 10

● Round	▲ Upper	▼ Lower
.012"	NTB12U-EFESE	NTB12L-EFESE
.014"	NTB14U-EFESE	NTB14L-EFESE
.016"	NTB16U-EFESE	NTB16L-EFESE
.018"	NTB18U-EFESE	NTB18L-EFESE
.020"	NTB20U-EFESE	NTB20L-EFESE

● Rectangle	▲ Upper	▼ Lower
.016" X .016"	NTB1616U-EFESE	NTB1616L-EFESE
.016" X .022"	NTB1622U-EFESE	NTB1622L-EFESE
.017" X .025"	NTB1725U-EFESE	NTB1725L-EFESE
.018" X .018"	NTB1818U-EFESE	NTB1818L-EFESE
.018" X .025"	NTB1825U-EFESE	NTB1825L-EFESE
.019" X .025"	NTB1925U-EFESE	NTB1925L-EFESE
.021" X .025"	NTB2125U-EFESE	NTB2125L-EFESE

TiNol-1™ Super Elastic Euro Form Econo Pk of 50

● Round	▲ Upper	▼ Lower
.012"	NTE12U-EFESE	NTE12L-EFESE
.014"	NTE14U-EFESE	NTE14L-EFESE
.016"	NTE16U-EFESE	NTE16L-EFESE
.018"	NTE18U-EFESE	NTE18L-EFESE
.020"	NTE20U-EFESE	NTE20L-EFESE

● Rectangle	▲ Upper	▼ Lower
.016" X .016"	NTE1616U-EFESE	NTE1616L-EFESE
.016" X .022"	NTE1622U-EFESE	NTE1622L-EFESE
.017" X .025"	NTE1725U-EFESE	NTE1725L-EFESE
.018" X .018"	NTE1818U-EFESE	NTE1818L-EFESE
.018" X .025"	NTE1825U-EFESE	NTE1825L-EFESE
.019" X .025"	NTE1925U-EFESE	NTE1925L-EFESE
.021" X .025"	NTE2125U-EFESE	NTE2125L-EFESE

TiNol-1™ Spooled Nitinol

TiNol-1™ spooled NiTi wire comes off the spool **arrow straight** and can be bent to an archform by giving more than required bend.

Sizes .012 and .014 can be left straight and engaged in brackets for initial leveling. .016, .018 and .020 can cause expansion of molars when left straight. This property can be used when **expansion** is actually required.

Eliminates cutting a piece from a preformed arch sectional arches and piggybacks

TiNol-1™ spooled NiTi is **Highest quality** of superelastic NiTi.

TiNol-1™ spooled has **Ultra smooth finish** for more aesthetic value and minimum friction

TiNol-1™ spooled NiTi is available On **15 feet spools** in following sizes :

Round: 012", 014", 016", 018", and 020".



TiNol-1™ Spooled Nitinol

● Round	
.012"	NT12-15FSE
.014"	NT14-15FSE
.016"	NT16-15FSE
.018"	NT18-15FSE
.020"	NT20-15FSE

TiNol-2™ Heat Activated Nitinol

TiNol-2™ thermal archwires have **martensite present** at room temperature, but go through a transformation change to austenite, which strengthens the wire once placed in the mouth.

TiNol-2™ is soft outside the mouth for easier ligation, but elastic modulus increases to produce a **fully austenitic wire** once in the mouth.

TiNol-2™ archwires are the wire of choice for **severe malocclusions**, and offer **earlier rectangular wire engagement**.

TiNol-2™ is a very **gentle wire** and **very comfortable** for the patient. A .016X.022 rectangular archwire has approximately the same force as a .016 round TiNol-1™ wire.

Softness of wire makes it **more vulnerable to permanent deformation** compared to super elastic NiTi wires. But if the TiNol-2™ is not deformed beyond the yield point while ligating, permanent deformation is avoidable.

Rectangular TiNol-2™

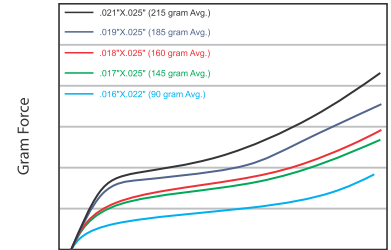

3 mm total deflection

Round TiNol-2™

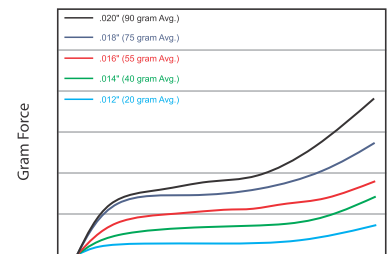

3 mm total deflection



Solo Pk of 10

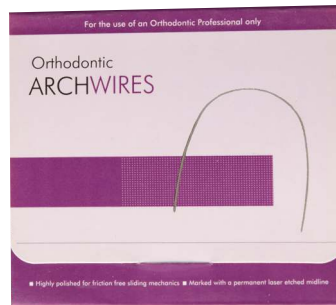

Box Pk of 10



Econo Pk of 50

TiNol-2™ Heat Activated **Natural Narrow** Solo Pk of 10

● Round	▲ Upper	▼ Lower
.012"	NTS12U-NNEHA	NTS12L-NNEHA
.014"	NTS14U-NNEHA	NTS14L-NNEHA
.016"	NTS16U-NNEHA	NTS16L-NNEHA
.018"	NTS18U-NNEHA	NTS18L-NNEHA
.020"	NTS20U-NNEHA	NTS20L-NNEHA

● Rectangle	▲ Upper	▼ Lower
.016" X .016"	NTS1616U-NNEHA	NTS1616L-NNEHA
.016" X .022"	NTS1622U-NNEHA	NTS1622L-NNEHA
.017" X .025"	NTS1725U-NNEHA	NTS1725L-NNEHA
.018" X .018"	NTS1818U-NNEHA	NTS1818L-NNEHA
.018" X .025"	NTS1825U-NNEHA	NTS1825L-NNEHA
.019" X .025"	NTS1925U-NNEHA	NTS1925L-NNEHA
.021" X .025"	NTS2125U-NNEHA	NTS2125L-NNEHA

TiNol-2™ Heat Activated **Natural Narrow** Box Pk of 10

● Round	▲ Upper	▼ Lower
.012"	NTB12U-NNEHA	NTB12L-NNEHA
.014"	NTB14U-NNEHA	NTB14L-NNEHA
.016"	NTB16U-NNEHA	NTB16L-NNEHA
.018"	NTB18U-NNEHA	NTB18L-NNEHA
.020"	NTB20U-NNEHA	NTB20L-NNEHA

● Rectangle	▲ Upper	▼ Lower
.016" X .016"	NTB1616U-NNEHA	NTB1616L-NNEHA
.016" X .022"	NTB1622U-NNEHA	NTB1622L-NNEHA
.017" X .025"	NTB1725U-NNEHA	NTB1725L-NNEHA
.018" X .018"	NTB1818U-NNEHA	NTB1818L-NNEHA
.018" X .025"	NTB1825U-NNEHA	NTB1825L-NNEHA
.019" X .025"	NTB1925U-NNEHA	NTB1925L-NNEHA
.021" X .025"	NTB2125U-NNEHA	NTB2125L-NNEHA

TiNol-2™ Heat Activated **Natural Narrow** Econo Pk of 50

● Round	▲ Upper	▼ Lower
.012"	NTE12U-NNEHA	NTE12L-NNEHA
.014"	NTE14U-NNEHA	NTE14L-NNEHA
.016"	NTE16U-NNEHA	NTE16L-NNEHA
.018"	NTE18U-NNEHA	NTE18L-NNEHA
.020"	NTE20U-NNEHA	NTE20L-NNEHA

● Rectangle	▲ Upper	▼ Lower
.016" X .016"	NTE1616U-NNEHA	NTE1616L-NNEHA
.016" X .022"	NTE1622U-NNEHA	NTE1622L-NNEHA
.017" X .025"	NTE1725U-NNEHA	NTE1725L-NNEHA
.018" X .018"	NTE1818U-NNEHA	NTE1818L-NNEHA
.018" X .025"	NTE1825U-NNEHA	NTE1825L-NNEHA
.019" X .025"	NTE1925U-NNEHA	NTE1925L-NNEHA
.021" X .025"	NTE2125U-NNEHA	NTE2125L-NNEHA

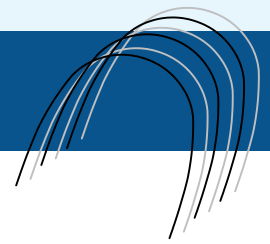

TiNol-2™ Heat Activated **Natural Form** Solo Pk of 10

● Round	▲ Upper	▼ Lower
.012"	NTS12U-NFEHA	NTS12L-NFEHA
.014"	NTS14U-NFEHA	NTS14L-NFEHA
.016"	NTS16U-NFEHA	NTS16L-NFEHA
.018"	NTS18U-NFEHA	NTS18L-NFEHA
.020"	NTS20U-NFEHA	NTS20L-NFEHA

● Rectangle	▲ Upper	▼ Lower
.016" X .016"	NTS1616U-NFEHA	NTS1616L-NFEHA
.016" X .022"	NTS1622U-NFEHA	NTS1622L-NFEHA
.017" X .025"	NTS1725U-NFEHA	NTS1725L-NFEHA
.018" X .018"	NTS1818U-NFEHA	NTS1818L-NFEHA
.018" X .025"	NTS1825U-NFEHA	NTS1825L-NFEHA
.019" X .025"	NTS1925U-NFEHA	NTS1925L-NFEHA
.021" X .025"	NTS2125U-NFEHA	NTS2125L-NFEHA

TiNol-2™ Heat Activated **Natural Form** Box Pk of 10

● Round	▲ Upper	▼ Lower
.012"	NTB12U-NFEHA	NTB12L-NFEHA
.014"	NTB14U-NFEHA	NTB14L-NFEHA
.016"	NTB16U-NFEHA	NTB16L-NFEHA
.018"	NTB18U-NFEHA	NTB18L-NFEHA
.020"	NTB20U-NFEHA	NTB20L-NFEHA

● Rectangle	▲ Upper	▼ Lower
.016" X .016"	NTB1616U-NFEHA	NTB1616L-NFEHA
.016" X .022"	NTB1622U-NFEHA	NTB1622L-NFEHA
.017" X .025"	NTB1725U-NFEHA	NTB1725L-NFEHA
.018" X .018"	NTB1818U-NFEHA	NTB1818L-NFEHA
.018" X .025"	NTB1825U-NFEHA	NTB1825L-NFEHA
.019" X .025"	NTB1925U-NFEHA	NTB1925L-NFEHA
.021" X .025"	NTB2125U-NFEHA	NTB2125L-NFEHA

TiNol-2™ Heat Activated **Natural Form** Econo Pk of 50

● Round	▲ Upper	▼ Lower
.012"	NTE12U-NFEHA	NTE12L-NFEHA
.014"	NTE14U-NFEHA	NTE14L-NFEHA
.016"	NTE16U-NFEHA	NTE16L-NFEHA
.018"	NTE18U-NFEHA	NTE18L-NFEHA
.020"	NTE20U-NFEHA	NTE20L-NFEHA

● Rectangle	▲ Upper	▼ Lower
.016" X .016"	NTE1616U-NFEHA	NTE1616L-NFEHA
.016" X .022"	NTE1622U-NFEHA	NTE1622L-NFEHA
.017" X .025"	NTE1725U-NFEHA	NTE1725L-NFEHA
.018" X .018"	NTE1818U-NFEHA	NTE1818L-NFEHA
.018" X .025"	NTE1825U-NFEHA	NTE1825L-NFEHA
.019" X .025"	NTE1925U-NFEHA	NTE1925L-NFEHA
.021" X .025"	NTE2125U-NFEHA	NTE2125L-NFEHA

TiNol-2™ Heat Activated ***Damon Form** Solo Pk of 10

● Round	▲ Upper	▼ Lower
.012"	NTS12U-DFEHA	NTS12L-DFEHA
.014"	NTS14U-DFEHA	NTS14L-DFEHA
.016"	NTS16U-DFEHA	NTS16L-DFEHA
.018"	NTS18U-DFEHA	NTS18L-DFEHA
.020"	NTS20U-DFEHA	NTS20L-DFEHA

● Rectangle	▲ Upper	▼ Lower
.016" X .016"	NTS1616U-DFEHA	NTS1616L-DFEHA
.016" X .022"	NTS1622U-DFEHA	NTS1622L-DFEHA
.017" X .025"	NTS1725U-DFEHA	NTS1725L-DFEHA
.018" X .018"	NTS1818U-DFEHA	NTS1818L-DFEHA
.018" X .025"	NTS1825U-DFEHA	NTS1825L-DFEHA
.019" X .025"	NTS1925U-DFEHA	NTS1925L-DFEHA
.021" X .025"	NTS2125U-DFEHA	NTS2125L-DFEHA

TiNol-2™ Heat Activated ***Damon Form** Box Pk of 10

● Round	▲ Upper	▼ Lower
.012"	NTB12U-DFEHA	NTB12L-DFEHA
.014"	NTB14U-DFEHA	NTB14L-DFEHA
.016"	NTB16U-DFEHA	NTB16L-DFEHA
.018"	NTB18U-DFEHA	NTB18L-DFEHA
.020"	NTB20U-DFEHA	NTB20L-DFEHA

● Rectangle	▲ Upper	▼ Lower
.016" X .016"	NTB1616U-DFEHA	NTB1616L-DFEHA
.016" X .022"	NTB1622U-DFEHA	NTB1622L-DFEHA
.017" X .025"	NTB1725U-DFEHA	NTB1725L-DFEHA
.018" X .018"	NTB1818U-DFEHA	NTB1818L-DFEHA
.018" X .025"	NTB1825U-DFEHA	NTB1825L-DFEHA
.019" X .025"	NTB1925U-DFEHA	NTB1925L-DFEHA
.021" X .025"	NTB2125U-DFEHA	NTB2125L-DFEHA

TiNol-2™ Heat Activated ***Damon Form** Econo Pk of 10

● Round	▲ Upper	▼ Lower
.012"	NTE12U-DFEHA	NTE12L-DFEHA
.014"	NTE14U-DFEHA	NTE14L-DFEHA
.016"	NTE16U-DFEHA	NTE16L-DFEHA
.018"	NTE18U-DFEHA	NTE18L-DFEHA
.020"	NTE20U-DFEHA	NTE20L-DFEHA

● Rectangle	▲ Upper	▼ Lower
.016" X .016"	NTE1616U-DFEHA	NTE1616L-DFEHA
.016" X .022"	NTE1622U-DFEHA	NTE1622L-DFEHA
.017" X .025"	NTE1725U-DFEHA	NTE1725L-DFEHA
.018" X .018"	NTE1818U-DFEHA	NTE1818L-DFEHA
.018" X .025"	NTE1825U-DFEHA	NTE1825L-DFEHA
.019" X .025"	NTE1925U-DFEHA	NTE1925L-DFEHA
.021" X .025"	NTE2125U-DFEHA	NTE2125L-DFEHA

*MO wire is in no way affiliated with or endorsed by Ormco Corporation or Dr. Dwight Damon

TiNol-2™ Heat Activated **Euro Form** Solo Pk of 10

● Round	▲ Upper	▼ Lower
.012"	NTS12U-EFEHA	NTS12L-EFEHA
.014"	NTS14U-EFEHA	NTS14L-EFEHA
.016"	NTS16U-EFEHA	NTS16L-EFEHA
.018"	NTS18U-EFEHA	NTS18L-EFEHA
.020"	NTS20U-EFEHA	NTS20L-EFEHA

● Rectangle	▲ Upper	▼ Lower
.016" X .016"	NTS1616U-EFEHA	NTS1616L-EFEHA
.016" X .022"	NTS1622U-EFEHA	NTS1622L-EFEHA
.017" X .025"	NTS1725U-EFEHA	NTS1725L-EFEHA
.018" X .018"	NTS1818U-EFEHA	NTS1818L-EFEHA
.018" X .025"	NTS1825U-EFEHA	NTS1825L-EFEHA
.019" X .025"	NTS1925U-EFEHA	NTS1925L-EFEHA
.021" X .025"	NTS2125U-EFEHA	NTS2125L-EFEHA

TiNol-2™ Heat Activated **Euro Form** Box Pk of 10

● Round	▲ Upper	▼ Lower
.012"	NTB12U-EFEHA	NTB12L-EFEHA
.014"	NTB14U-EFEHA	NTB14L-EFEHA
.016"	NTB16U-EFEHA	NTB16L-EFEHA
.018"	NTB18U-EFEHA	NTB18L-EFEHA
.020"	NTB20U-EFEHA	NTB20L-EFEHA

● Rectangle	▲ Upper	▼ Lower
.016" X .016"	NTB1616U-EFEHA	NTB1616L-EFEHA
.016" X .022"	NTB1622U-EFEHA	NTB1622L-EFEHA
.017" X .025"	NTB1725U-EFEHA	NTB1725L-EFEHA
.018" X .018"	NTB1818U-EFEHA	NTB1818L-EFEHA
.018" X .025"	NTB1825U-EFEHA	NTB1825L-EFEHA
.019" X .025"	NTB1925U-EFEHA	NTB1925L-EFEHA
.021" X .025"	NTB2125U-EFEHA	NTB2125L-EFEHA

TiNol-2™ Heat Activated **Euro Form** Econo Pk of 10

● Round	▲ Upper	▼ Lower
.012"	NTE12U-EFEHA	NTE12L-EFEHA
.014"	NTE14U-EFEHA	NTE14L-EFEHA
.016"	NTE16U-EFEHA	NTE16L-EFEHA
.018"	NTE18U-EFEHA	NTE18L-EFEHA
.020"	NTE20U-EFEHA	NTE20L-EFEHA

● Rectangle	▲ Upper	▼ Lower
.016" X .016"	NTE1616U-EFEHA	NTE1616L-EFEHA
.016" X .022"	NTE1622U-EFEHA	NTE1622L-EFEHA
.017" X .025"	NTE1725U-EFEHA	NTE1725L-EFEHA
.018" X .018"	NTE1818U-EFEHA	NTE1818L-EFEHA
.018" X .025"	NTE1825U-EFEHA	NTE1825L-EFEHA
.019" X .025"	NTE1925U-EFEHA	NTE1925L-EFEHA
.021" X .025"	NTE2125U-EFEHA	NTE2125L-EFEHA



TiNoI-RC™ Reverse Curve of Spee Nitinol

Forget about the frequent wire changes required because of bite opening bends being flattened by occlusal forces. Use our TiNoI-RC reverse curve of Spee archwires available in **both Super elastic and Thermal materials.**

TiNoI-RC™ wires are an excellent choice for leveling and bite opening. You can also **consolidate the spaces and close the bite** with these wires.

TiNoI-RC™ wires have **Ultra smooth finish** for more aesthetic value and minimum friction

TiNoI-RC™ archwires are having distinct and **permanent etched markings** for midline. While upper arches have three midline marks, lower ones have one midline etch mark.

- Super Elastic or Thermal
- Laser Marked Midline
- Diamond Polished
- Constant Force



Super Elastic RCS Solo Pk of 10

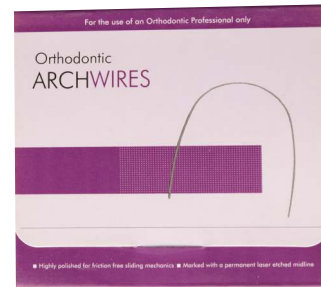

Heat Activated RCS Box Pk of 10

TiNoI-RC™ Super Elastic RCS Solo Pk of 10

● Round	▲ Upper	▼ Lower
.014"	NTS14U-RCESE	NTS14L-RCESE
.016"	NTS16U-RCESE	NTS16L-RCESE
.018"	NTS18U-RCESE	NTS18L-RCESE
.020"	NTS20U-RCESE	NTS20L-RCESE
● Rectangle	▲ Upper	▼ Lower
.016" X .016"	NTS1616U-RCESE	NTS1616L-RCESE
.016" X .022"	NTS1622U-RCESE	NTS1622L-RCESE
.017" X .025"	NTS1725U-RCESE	NTS1725L-RCESE
.018" X .025"	NTS1825U-RCESE	NTS1825L-RCESE
.019" X .025"	NTS1925U-RCESE	NTS1925L-RCESE
.021" X .025"	NTS2125U-RCESE	NTS2125L-RCESE

TiNoI-RC™ Super Elastic RCS Box Pk of 10

● Round	▲ Upper	▼ Lower
.014"	NTB14U-RCESE	NTB14L-RCESE
.016"	NTB16U-RCESE	NTB16L-RCESE
.018"	NTB18U-RCESE	NTB18L-RCESE
.020"	NTB20U-RCESE	NTB20L-RCESE
● Rectangle	▲ Upper	▼ Lower
.016" X .016"	NTB1616U-RCESE	NTB1616L-RCESE
.016" X .022"	NTB1622U-RCESE	NTB1622L-RCESE
.017" X .025"	NTB1725U-RCESE	NTB1725L-RCESE
.018" X .025"	NTB1825U-RCESE	NTB1825L-RCESE
.019" X .025"	NTB1925U-RCESE	NTB1925L-RCESE
.021" X .025"	NTB2125U-RCESE	NTB2125L-RCESE

TiNoI-RC™ Heat Activated RCS Solo Pk of 10

● Round	▲ Upper	▼ Lower
.016"	NTS16U-RCEHA	NTS16L-RCEHA
.018"	NTS18U-RCEHA	NTS18L-RCEHA
.020"	NTS20U-RCEHA	NTS20L-RCEHA
● Rectangle	▲ Upper	▼ Lower
.016" X .016"	NTS1616U-RCEHA	NTS1616L-RCEHA
.016" X .022"	NTS1622U-RCEHA	NTS1622L-RCEHA
.017" X .025"	NTS1725U-RCEHA	NTS1725L-RCEHA
.018" X .025"	NTS1825U-RCEHA	NTS1825L-RCEHA
.019" X .025"	NTS1925U-RCEHA	NTS1925L-RCEHA
.021" X .025"	NTS2125U-RCEHA	NTS2125L-RCEHA

TiNoI-RC™ Heat Activated RCS Box Pk of 10

● Round	▲ Upper	▼ Lower
.016"	NTB16U-RCEHA	NTB16L-RCEHA
.018"	NTB18U-RCEHA	NTB18L-RCEHA
.020"	NTB20U-RCEHA	NTB20L-RCEHA
● Rectangle	▲ Upper	▼ Lower
.016" X .016"	NTB1616U-RCEHA	NTB1616L-RCEHA
.016" X .022"	NTB1622U-RCEHA	NTB1622L-RCEHA
.017" X .025"	NTB1725U-RCEHA	NTB1725L-RCEHA
.018" X .025"	NTB1825U-RCEHA	NTB1825L-RCEHA
.019" X .025"	NTB1925U-RCEHA	NTB1925L-RCEHA
.021" X .025"	NTB2125U-RCEHA	NTB2125L-RCEHA

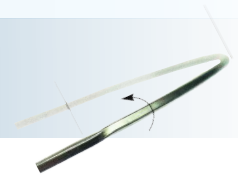

TiNoI-TQ™ Pre Torqued Nitinol

TiNoI-TQ™ nitinol wires provide **ideal most physiological torque force** compared to stiff SS wires. No need to worry about discomfort and pain to your patient.

TiNoI-TQ™ wires **provide early application of torque to anteriors** where needed. So that the total treatment time is reduced specially in extraction cases with steep inter-incisal angle at the beginning of treatment.

TiNoI-TQ™ nitinol wires have standard **20° of torque built** into the anterior region of each wire. Wire can be removed as soon as the required torque is achieved.

Torque force can be applied **labially or lingually** by reversing the orientation of the wire.

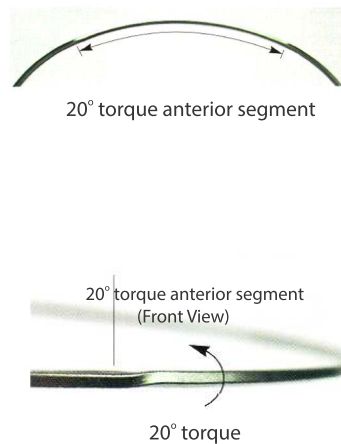
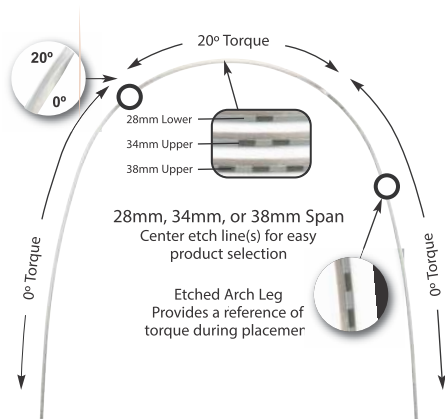

Tooth Friendly Forces
Laser Marked Midline
Diamond Polished
Kink Resistant

TiNoI-TQ™ Pre Torqued Nitinol Archwires Natural Form

● Rectangle	▲ Upper 38MM	▲ Upper 34MM	▼ Lower 28MM
.017" X .025"	NTS1725U-NFE38	NTS1725U-NFE34	NTS1725L-NFE28
.018" X .025"	NTS1825U-NFE38	NTS1825U-NFE34	NTS1825L-NFE28
.019" X .025"	NTS1925U-NFE38	NTS1925U-NFE34	NTS1925L-NFE28
.021" X .025"	NTS2125U-NFE38	NTS2125U-NFE34	Not Available

TiNoI-TQ™ Pre Torqued Nitinol Archwires Damon Form

● Rectangle	▲ Upper 38MM	▲ Upper 34MM	▼ Lower 28MM
.017" X .025"	NTS1725U-DFE38	NTS1725U-DFE34	NTS1725L-DFE28
.018" X .025"	NTS1825U-DFE38	NTS1825U-DFE34	NTS1825L-DFE28
.019" X .025"	NTS1925U-DFE38	NTS1925U-DFE34	NTS1925L-DFE28
.021" X .025"	NTS2125U-DFE38	NTS2125U-DFE34	Not Available

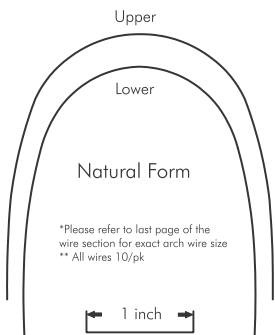

*Please refer to last page of the wire section for exact arch wire size
** All wires 10/pk

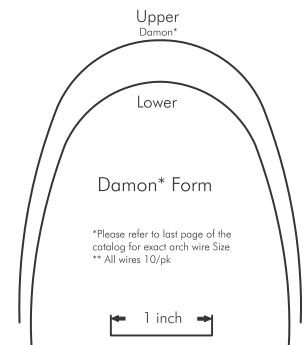

*Please refer to last page of the catalog for exact arch wire size
** All wires 10/pk

*MO wire is in no way affiliated with or endorsed by Ormco Corporation or Dr. Dwight Damon



TiNoI-1™ Nitinol Springs

TiNoI-1™ NiTi open coil spring: Open coil springs **open and maintain spaces with constant, gentle force**. From start to finish this spring delivers constant, unvarying force for predictable results—even when spring compression is changed the force stays the same.

.010X.030 spring in 15" lengths

TiNoI-1™ NiTi open coil spring

.010" x .030" 15" on spool	NT1030O-15I
.012" x .030" 15" on spool	NT1230O-15I



TiNoI-1™ NiTi closed coil spring with eyelets: Use closed coil eyelet springs to close spaces with ease, without patient discomfort and within a predictable time period.

.010X.030 spring in 9mm and 12mm lengths in packs of 10

TiNoI-1™ NiTi closed coil spring

.010" x .030" 9mm pk of 10	NT1030CB-09M
.010" x .030" 12mm pk of 10	NT1030CB-12M



TiNoI-1™ NiTi closed coil spring with eyelets for class II correction: **Use it in place of class II elastics** when your patient compliance is a problem. Tie it once and it would work permanently for months. Spring should be covered with soft sleeve to eliminate pinching and food trapping.

TiNoI-1™ .010X.030 spring in 15 mm and 18 mm lengths in packs of 10

TiNoI-1™ NiTi closed coil spring

.010" x .030" 15mm pk of 10	NT1030CB-15M
.010" x .030" 18mm pk of 10	NT1030CB-18M



Open or Closed | Constant Force
Diamond Polished | Medium Force



TiNoI-3F™ Progressive Force Nitinol

TiNoI-3F™ Progressive Force wire offers **three force levels** in one amazing archwire

Anterior Region:

The incisor segment has the **lowest heat-activated force** level specific to moving small, single rooted teeth. The TiNoI-3F™ provides gentle forces for patient comfort, reduces unnecessary tooth pressure and decreases the possibility of root resorption.

Bicuspid Region:

This segment of the TiNoI-3F™ archwire delivers a **slightly increased force** for moving the larger bicuspids or premolars. The progressively increased force provides quick leveling and alignment to speed up treatment time, without compromising patient comfort levels.

Molar Region:

The posterior segment of the TiNoI-3F™ generates the **most force** in order to align the larger, more difficult to move first and second molars. Regular archwires have only one force level throughout, which would require 2 or 3 wire changes to achieve the same movement you can get with 1

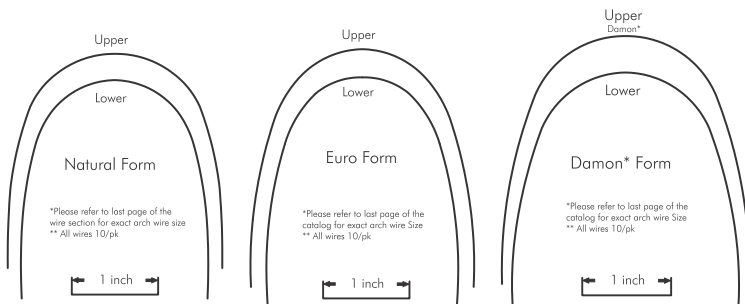
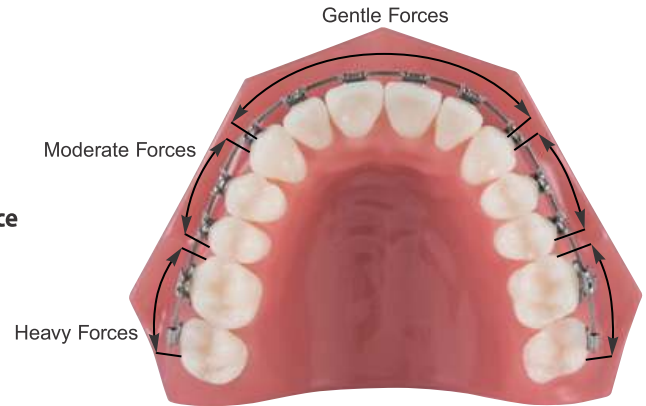

TiNoI-3F™ Progressive Force (3Force) Natural Form

● Round	▲ Upper	▼ Lower
.016"	NTS16U-NFE3	NTS16L-NFE3
.018"	NTS18U-NFE3	NTS18L-NFE3
● Rectangle	▲ Upper	▼ Lower
.016" X .016"	NTS1616U-NFE3	NTS1616L-NFE3
.016" X .022"	NTS1622U-NFE3	NTS1622L-NFE3
.017" X .025"	NTS1725U-NFE3	NTS1725L-NFE3
.018" X .018"	NTS1818U-NFE3	NTS1818L-NFE3
.018" X .025"	NTS1825U-NFE3	NTS1825L-NFE3
.019" X .025"	NTS1925U-NFE3	NTS1925L-NFE3
.021" X .025"	NTS2125U-NFE3	NTS2125L-NFE3

TiNoI-3F™ Progressive Force (3Force) Euro Form

● Round	▲ Upper	▼ Lower
.016"	NTS16U-EFE3	NTS16L-EFE3
.018"	NTS18U-EFE3	NTS18L-EFE3
● Rectangle	▲ Upper	▼ Lower
.016" X .016"	NTS1616U-EFE3	NTS1616L-EFE3
.016" X .022"	NTS1622U-EFE3	NTS1622L-EFE3
.017" X .025"	NTS1725U-EFE3	NTS1725L-EFE3
.018" X .018"	NTS1818U-EFE3	NTS1818L-EFE3
.018" X .025"	NTS1825U-EFE3	NTS1825L-EFE3
.019" X .025"	NTS1925U-EFE3	NTS1925L-EFE3
.021" X .025"	NTS2125U-EFE3	NTS2125L-EFE3

TiNoI-3F™ Progressive Force (3Force) Damon Form

● Round	▲ Upper	▼ Lower
.016"	NTS16U-DFE3	NTS16L-DFE3
.018"	NTS18U-DFE3	NTS18L-DFE3
● Rectangle	▲ Upper	▼ Lower
.016" X .016"	NTS1616U-DFE3	NTS1616L-DFE3
.016" X .022"	NTS1622U-DFE3	NTS1622L-DFE3
.017" X .025"	NTS1725U-DFE3	NTS1725L-DFE3
.018" X .018"	NTS1818U-DFE3	NTS1818L-DFE3
.018" X .025"	NTS1825U-DFE3	NTS1825L-DFE3
.019" X .025"	NTS1925U-DFE3	NTS1925L-DFE3
.021" X .025"	NTS2125U-DFE3	NTS2125L-DFE3

*MO wire is in no way affiliated with or endorsed by Ormco Corporation or Dr. Dwight Damon

Acti-4S™ Stainless Steel Wires(304VAR)

Why MO's Acti-4S™ Stainless Steel Archwires are **superior** to other companies!

All our Acti-4S™ archwires are manufactured from 304VAR material. **304VAR is Vacuum Arc Remelted (VAR) stainless steel.** This process yields a more uniform chemistry with minimal voids and contaminants. It would reduce any chances of brittleness that may lead to breakage.

The Acti-4S™ material properties help us in getting **true square** or rectangular wire in cross section with minimum corner radii.

The ease of joining Acti-4S™ with **solder or welding**, combined with excellent strength makes it most desirable for orthodontic application.

During Acti-4S™ wire drawing, we insure that all our archwires are having **minimum corner radii** and are **free of film on edges** formed by carbide precipitation phenomenon that occurs if strict quality controls are not used during manufacturing process.

Tightest tolerance in size of Acti-4S™ wire is maintained using **continuous laser measuring** equipment, which would automatically stop the production if the size variation were there.

All Acti-4S™ wires are tested for required tensile strength before and after the archwire forming process to ensure accurate tensile specifications. Various **bend testing** involving most intricate bends is performed on each lot to verify proper required ductility.



304 VAR Stainless Steel
Ideal Tensile Strength
Diamond Drawn
Laser Marked Midline

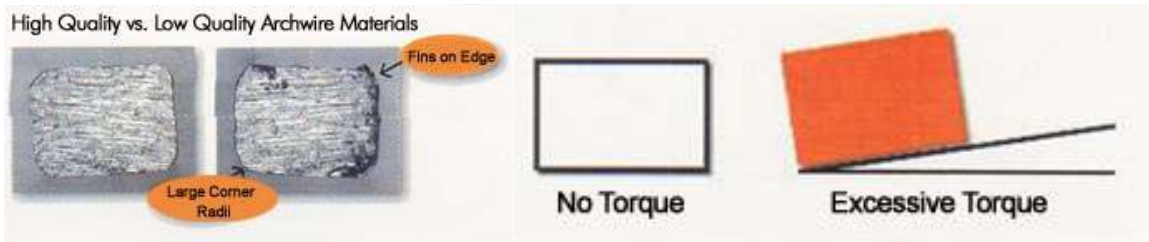

Ready Acti-4S™ archwires are then subjected to strict **inspection requirements for torque and arch shape** one by one. Each wire has to be perfectly flat not in front area but also in posterior sections. For we very well understand that torque is a serious condition that can cause harmful effects to an orthodontist's patient.



Solo Pk of 10

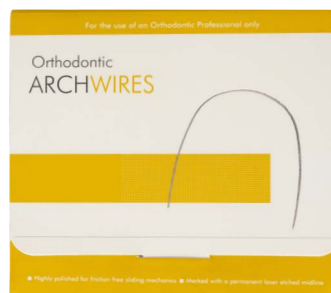

Box Pk of 10



Econo Pk of 50



Acti-4S™ Posted Wires

.030" brass post | *Silver soldered*
Upper 34mm to 42mm | *Lower 24mm to 32mm*

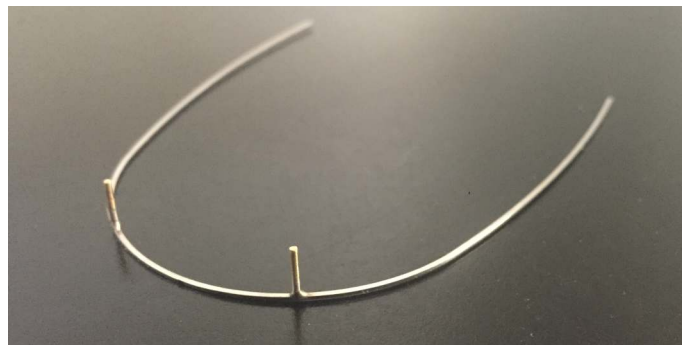
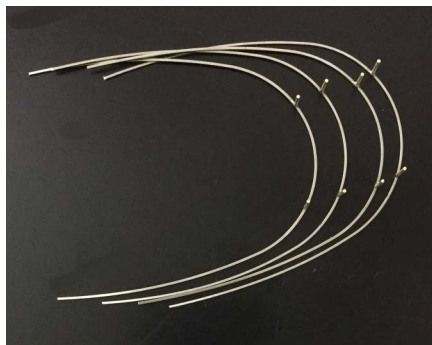

Stainless Steel Euro Form Solo Pk of 10

Available Sizes:
Lower 24, 26, 28, 30, 32 MM
Upper 34, 36, 38, 40, 42 MM

Please note that sizes
28MM (Lower) & 36MM (Upper)
are used the most

	Natural	Euro	Damon
■ Upper			
.016" X .025"	Not Available	Not Available	SS1625U-DFEP
.017" X .025"	SS1725U-NFEP	SS1725U-EFEP	SS1725U-DFEP
.019" X .025"	SS1925U-NFEP	SS1925U-EFEP	SS1925U-DFEP
■ Lower			
.017" X .025"	SS1725L-NFEP	SS1725L-EFEP	SS1725L-DFEP
.019" X .025"	SS1925L-NFEP	SS1925L-EFEP	SS1925L-DFEP

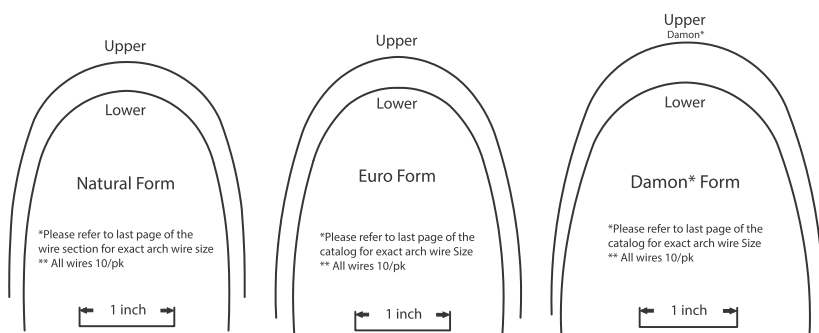

*MO wire is in no way affiliated with or endorsed by Ormco Corporation or Dr. Dwight Damon



Acti-4S™ Stainless Steel Ligature Wires

Acti-4S™ Stainless Steel Ligature wires are manufactured with the highest quality medical grade type **304VAR stainless steel**

Acti-4S™ Stainless Steel Ligature wires are having **bright finish** and are **dead soft** high strength wires

Acti-4S™ Stainless Steel Ligature wires are available as **Two Oz Spools, Preformed ties, Shorty ties and Kobayashi tie**

Acti-4S™
Ligature Wire spool 2 Oz

.009"	AWL-09-2OZ
.010"	AWL-10-2OZ
.012"	AWL-12-2OZ



Acti-4S™
Ligature Wire Shorty Ties 500/pk

.010"	AWL-10-ST5
-------	------------

Acti-4S™
Ligature Wire Preformed Ties 500/pk

.009"	AWL-09-PF5
.010"	AWL-10-PF5
.012"	AWL-12-PF5

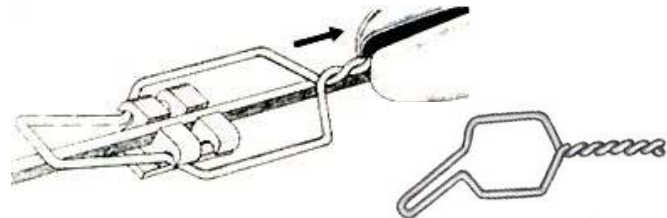

Acti-4S™
Short Kobayashi Ties 100/pk

.012"	AWL-12-KT2
.014"	AWL-14-KT2



Acti-4S™
Long Kobayashi Ties 100/pk

.010"	AWL-10-KT1
.012"	AWL-12-KT1
.014"	AWL-14-KT1

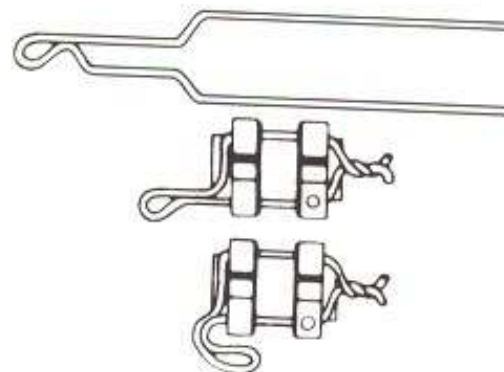

304 VAR Stainless Steel | Dead Soft
Diamond Drawn | Mirror Bright Finish



Acti-4S™ Stainless Steel Co-Axial Wires

Acti-4S™ Stainless Steel Co-axial wires are manufactured with the highest quality medical grade type **304VAR stainless steel**

Acti-4S™ Stainless Steel Co-axial wires combine three important features making it the wire of choice for **initial leveling and aligning** where teeth are seriously malposed.

Acti-4S™ Stainless Steel Co-axial wire are made using five strands of stainless steel wire wrapped around a stainless steel core wire. The wire **won't fray when cut**.

Acti-4S™ Stainless Steel Co-axial wire's **wide working range** provides ability to move teeth without undue discomfort to patient. Large diameters can be used earlier in treatment to achieve control

304 VAR Stainless Steel | Long Working Range
Won't Fray When Cut | 30 Feet Spools

Acti-4S™
Coaxial wire spool 30 Feet Spool

.0155"	CO155S-30F
.0175"	CO175S-30F
.0195"	CO195S-30F

Acti-4S™
Dead Soft Coaxial wire for fixed retainer
spool 15 Feet Spool

.0155"	COS155S-15F
.0175"	COS175S-15F
.0195"	COS195S-15F

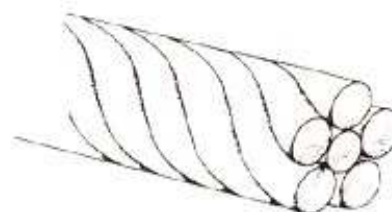



Ti-Alloy™ Beta Titanium (TMA) wires

Ti-Alloy™ Beta Titanium archwires are **nickel free**

Ti-Alloy™ Beta Titanium archwires offer the **bendability** of stainless steel and **flexibility** of nickel titanium wires.

Ti-Alloy™ archwires have a smooth **polished** surface for excellent sliding mechanics and provide moderate wire stiffness levels at 50% less than stainless steel.

Ti-Alloy™ Beta Titanium archwires offer **excellent formability**, which is ideal for patient specific detailed bends along with gentler force levels for increased patient comfort

Ti-Alloy™ Beta Titanium archwires are provided in **long arch wire shapes** that allow fabrication of "T Loops" and other loops.

Ti-Alloy™ TMA Natural Form Ink Midline

● Round	▲ Upper	▼ Lower
.016"	TMS16U-NFILG	TMS16L-NFILG
.018"	TMS18U-NFILG	TMS18L-NFILG
● Rectangle	▲ Upper	▼ Lower
.016" X .022"	TMS1622U-NFILG	TMS1622L-NFILG
.017" X .025"	TMS1725U-NFILG	TMS1725L-NFILG
.019" X .025"	TMS1925U-NFILG	TMS1925L-NFILG
.021" X .025"	TMS2125U-NFILG	TMS2125L-NFILG

Ti-Alloy™ TMA Damon* Form Ink Midline

● Round	▲ Upper	▼ Lower
.016"	TMS16U-DFILG	TMS16L-DFILG
.018"	TMS18U-DFILG	TMS18L-DFILG
● Rectangle	▲ Upper	▼ Lower
.016" X .022"	TMS1622U-DFILG	TMS1622L-DFILG
.017" X .025"	TMS1725U-DFILG	TMS1725L-DFILG
.019" X .025"	TMS1925U-DFILG	TMS1925L-DFILG
.021" X .025"	TMS2125U-DFILG	TMS2125L-DFILG

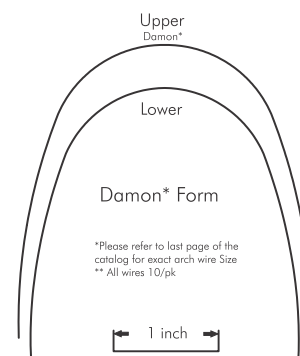
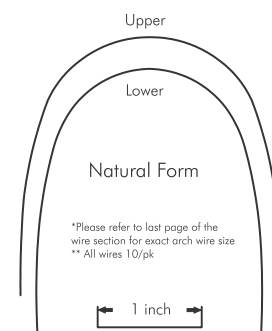

*MO wire is in no way affiliated with or endorsed by Ormco Corporation or Dr. Dwight Damon

Micro-KOT™ Coated Wires and Accessories

All Micro-KOT™ coated wires and accessories are Micro-Teflon coated using very fine particles of Teflon. Fine particles stick better.

All Micro-KOT™ coated wires and accessories are having very thin coating just sufficient to mask the color of metal. Thin coating is more chip resistant.



Tooth-colored archwires are ink midlined (black upper - red lower) for symmetrical identification. After archwire placement, rub midline gently with a cotton swab dipped in isopropyl alcohol. This will remove the majority of ink.



Micro Teflon Particles | Very Thin Coating
Chip Resistant | NiTi and Stainless Steel

Micro-KOT™

Nitinol Super Elastic Natural Form Coated

● Round	▲ Upper	▼ Lower
.012"	NTS12U-NFISEC	NTS12L-NFISEC
.014"	NTS14U-NFISEC	NTS14L-NFISEC
.016"	NTS16U-NFISEC	NTS16L-NFISEC
.018"	NTS18U-NFISEC	NTS18L-NFISEC
.020"	NTS20U-NFISEC	NTS20L-NFISEC

● Rectangle	▲ Upper	▼ Lower
.016" X .016"	NTS1616U-NFISEC	NTS1616L-NFISEC
.016" X .022"	NTS1622U-NFISEC	NTS1622L-NFISEC
.017" X .025"	NTS1725U-NFISEC	NTS1725L-NFISEC
.018" X .018"	NTS1818U-NFISEC	NTS1818L-NFISEC
.018" X .025"	NTS1825U-NFISEC	NTS1825L-NFISEC
.019" X .025"	NTS1925U-NFISEC	NTS1925L-NFISEC
.021" X .025"	NTS2125U-NFISEC	NTS2125L-NFISEC

Micro-KOT™

Nitinol Super Elastic Euro Form Coated

● Round	▲ Upper	▼ Lower
.012"	NTS12U-EFISEC	NTS12L-EFISEC
.014"	NTS14U-EFISEC	NTS14L-EFISEC
.016"	NTS16U-EFISEC	NTS16L-EFISEC
.018"	NTS18U-EFISEC	NTS18L-EFISEC
.020"	NTS20U-EFISEC	NTS20L-EFISEC

● Rectangle	▲ Upper	▼ Lower
.016" X .016"	NTS1616U-EFISEC	NTS1616L-EFISEC
.016" X .022"	NTS1622U-EFISEC	NTS1622L-EFISEC
.017" X .025"	NTS1725U-EFISEC	NTS1725L-EFISEC
.018" X .018"	NTS1818U-EFISEC	NTS1818L-EFISEC
.018" X .025"	NTS1825U-EFISEC	NTS1825L-EFISEC
.019" X .025"	NTS1925U-EFISEC	NTS1925L-EFISEC
.021" X .025"	NTS2125U-EFISEC	NTS2125L-EFISEC



Micro-KOT™

StainleSSS Steel 304V Natural Form Coated

● Round	▲ Upper	▼ Lower
.012"	SSS12U-NFIC	SSS12L-NFIC
.014"	SSS14U-NFIC	SSS14L-NFIC
.016"	SSS16U-NFIC	SSS16L-NFIC
.018"	SSS18U-NFIC	SSS18L-NFIC
.020"	SSS20U-NFIC	SSS20L-NFIC

● Rectangle	▲ Upper	▼ Lower
.016" X .016"	SSS1616U-NFIC	SSS1616L-NFIC
.016" X .022"	SSS1622U-NFIC	SSS1622L-NFIC
.016" X .025"	SSS1625U-NFIC	SSS1625L-NFIC
.018" X .018"	SSS1818U-NFIC	SSS1818L-NFIC
.017" X .025"	SSS1725U-NFIC	SSS1725L-NFIC
.018" X .025"	SSS1825U-NFIC	SSS1825L-NFIC
.019" X .025"	SSS1925U-NFIC	SSS1925L-NFIC
.021" X .025"	SSS2125U-NFIC	SSS2125L-NFIC

Micro-KOT™

StainleSSS Steel 304V Euro Form Coated

● Round	▲ Upper	▼ Lower
.012"	SSS12U-EFIC	SSS12L-EFIC
.014"	SSS14U-EFIC	SSS14L-EFIC
.016"	SSS16U-EFIC	SSS16L-EFIC
.018"	SSS18U-EFIC	SSS18L-EFIC
.020"	SSS20U-EFIC	SSS20L-EFIC

● Rectangle	▲ Upper	▼ Lower
.016" X .016"	SSS1616U-EFIC	SSS1616L-EFIC
.016" X .022"	SSS1622U-EFIC	SSS1622L-EFIC
.016" X .025"	SSS1625U-EFIC	SSS1625L-EFIC
.018" X .018"	SSS1818U-EFIC	SSS1818L-EFIC
.017" X .025"	SSS1725U-EFIC	SSS1725L-EFIC
.018" X .025"	SSS1825U-EFIC	SSS1825L-EFIC
.019" X .025"	SSS1925U-EFIC	SSS1925L-EFIC
.021" X .025"	SSS2125U-EFIC	SSS2125L-EFIC





Archwire Forms Actual Size

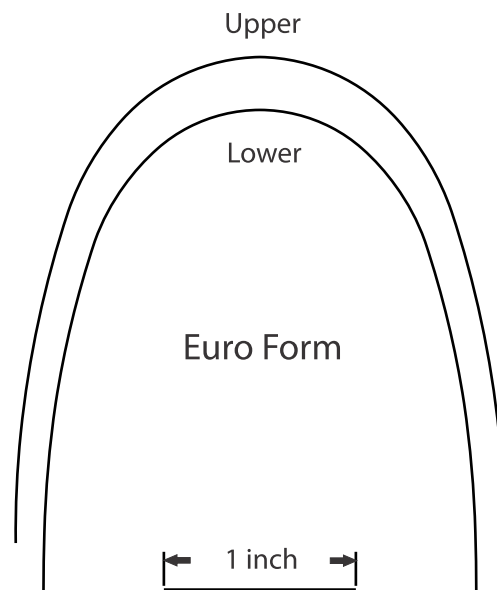
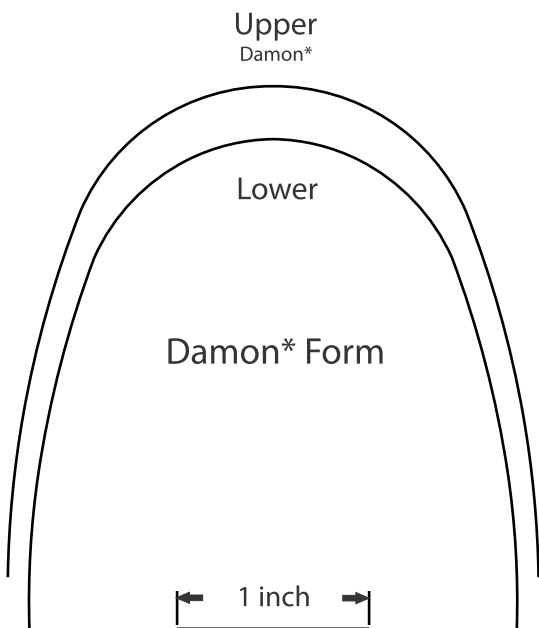
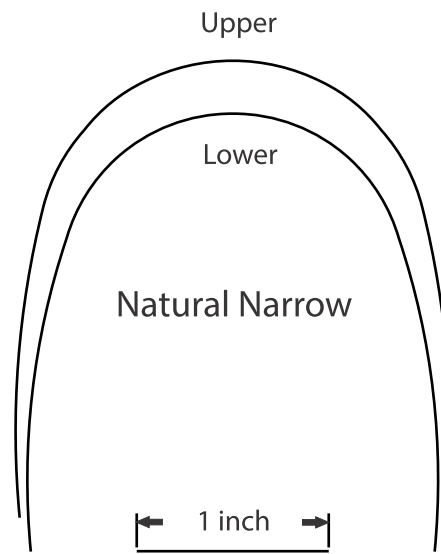
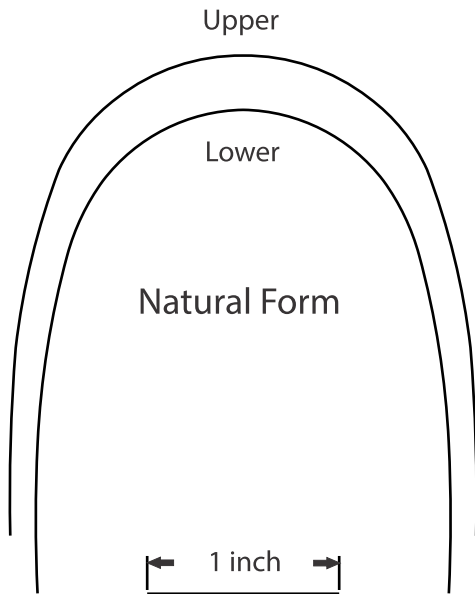

*Damon Compatible. "Damon" is a registered trademark of Ormco Corporation

*MO wire is in no way affiliated with or endorsed by Ormco Corporation or Dr. Dwight Damon

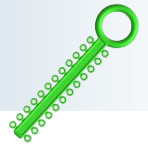

			Ties Pk of 1008
	Clear	● ●	LT-001
	White	●	LT-002
	Pearl	●	LT-003
	Peach	●	LT-004
	Bronze	●	LT-005
	Silver	●	LT-006
	Gray	●	LT-007
	Black	●	LT-008
	Lime	●	LT-009
	Shamrock	●	LT-010
	Green	●	LT-011
	Aqua	●	LT-012
	Teal	●	LT-013
	Light Blue	●	LT-014
	Blue	●	LT-015
	Navy	●	LT-016
	Purple	●	LT-017
	Burgundy	●	LT-018
	Red	●	LT-019
	Fire Red	●	LT-020
	Rose	●	LT-021
	Pink	●	LT-022
	Bubblegum	●	LT-023
	Coral	●	LT-024
	Dark Orange	●	LT-025
	Orange	●	LT-026
	Yellow	●	LT-027

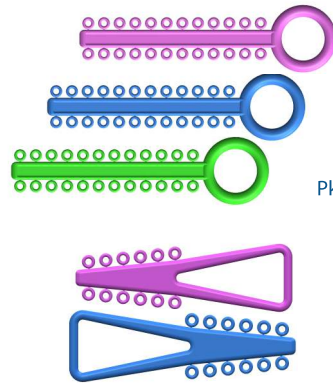

Ties
Pk of 1008

12 Ties EasyTies

Separators Molded
Radio-Opaque
Pk of 500

Cat.No. SEP-M500

Separators
Radio-Opaque
Pk of 500

Cat.No. SEP-L500

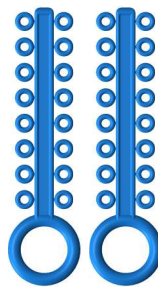

LT-101

● Assorted Colours Ties Pk
3 sticks each from colors marked
on chart (42 total sticks)

LT-102

● Assorted Coloured Ties Pk
3 sticks each from colors marked
on chart (42 total sticks)

12 Ties EasyTies are 84 ties in one pk 6 sticks each
For EasyTies please use Catalog No. prefix LTE-XXX



Elastomeric Thread
Grey .030" X 25 Ft

Cat.No. ELT-GR



Elastomeric Chain

Short Clear..... ECS-CL
Closed Clear... ECC-CL
Long Clear..... ECL-CL
Short Grey..... ECS-GR
Closed Grey... ECC-GR
Long Grey..... ECL-GR



Elastomeric Tissue Guard/
Lip-Bumper Tubing Grey
.045" X 10 Ft

Cat.No. ETG-GR



Elastomeric Wire Sleeve
Grey .027" ID X 10 Ft

Cat.No. EWS-GR



ElastoSure™
ELASTICS
ELASTOMERICS
by Modern Orthodontics

Intra Oral/Extra Oral
Colored or Natural
Hydrolysis resistant
Stain Resistant

Intra Oral/1000pk

Extra Oral/1000pk

3/8" 3.0 oz Pink	EL30-PK38
3/8" 3.0 oz Tooth Color	EL30-TC38
5/16" 3.5 oz Green	EL35-GR56
5/16" 3.5 oz Tooth Color	EL35-TC56
5/16" 2.5 oz Yellow	EL25-YE56
1/4" 4.0 oz Blue	EL40-BL14
1/4" 4.0 oz Tooth Color	EL40-TC14
3/16" 4.5 oz Grey	EL45-GY36
3/16" 4.5 oz Tooth Color	EL45-TC36
1/8" 4.5 oz Red	EL45-RD18

3/8" 14.0 oz Lime Green	EL140-LG38
3/8" 8.0 oz Lime Green	EL80-LG38
5/16" 14.0 oz Lime Green	EL140-LG56
5/16" 8.0 oz Lime Green	EL80-LG56
1/4" 14.0 oz Lime Green	EL140-LG14



TruBond-NP™

LIGHT CURED

Nano Particles Formulation
Made in USA
Enhanced Bond Strength
Contains Fluoride

Kit containing 1 Syringe of paste 5 gm, sealant resin primer 3 ml & Etch syringe 2.5 ml... Cat.No. TBN-LCA-1SK
1 Syringes of L C paste 5 gm..... Cat.No. TBN-LCA-5GM
Bond 3 ml..... Cat.No. TBN-LCB-3ML



TruBond™

LIGHT CURED

Contains Fluoride
Made in USA
Excellent Bond Strength
Tooth Colored

Kit containing 1 Syringe of paste 5 gm, sealant resin primer 3.5 gm & Etch syringe 3 gm... Cat.No. TB-LCA-1SK
1 Syringes of L C paste 5 gm..... Cat.No. TB-LCA-5GM
Bond 3.5 gm..... Cat.No. TB-LCB-3.5GM



TruBond-NP™

NO-MIX

Nano Particles Formulation
Made in USA
Enhanced Bond Strength
Contains Fluoride

Kit containing 2 Syringes of paste 5 gm each, activator primer 7 ml & Etch bottle 5 ml..... Cat.No. TBN-NM-2SK
1 Syringes of paste 5 gm..... Cat.No. TBN-NM-5GM
Activator primer 12.5 ml..... Cat.No. TBN-NM-125ML



TruBond™

NO-MIX

Contains Fluoride
Made in USA
Excellent Bond Strength
Tooth Colored

Kit containing 4 Syringes of paste 5 gm each, activator primer 16 gm & Etch bottle 9 gm..... Cat.No. TB-NM-4SK
Kit containing 2 Syringes of paste 5 gm each, activator primer 9 gm & Etch bottle 6 gm..... Cat.No. TB-NM-2SK
1 Syringes of paste 5 gm..... Cat.No. TB-NM-5GM
Activator primer 16 gm..... Cat.No. TB-NM-16GM



TruBond™

ETCHANTS

37% Orthophosphoric Acid
Made in USA
Thixotropic Gel
Colored for visibility

Etching gel syringe of 3 gm..... Cat.No. TB-EGS-3GM
Etching gel bottle 16 gm..... Cat.No. TB-EGB-16GM

Extra Oral™

Appliances

Headgear
Heavy Force Safety
Washable



HIGH PULL HEAD GEAR

Headgear set with safety releasing modules and facebow... Cat.No. HGH-001
Headgear with safety releasing modules.....Cat.No.HGH-002
Headgear (without safety releasing modules and facebow) ...Cat.No.HGH-003

Comfy Neckpad
Heavy Force Safety
Washable



NECK PAD SET

Neck Pad set with safety releasing modules and facebow.... Cat.No. NPH-001
Neck Pad with safety releasing modules..... Cat.No. NPH-002
Neck Pad (without safety releasing modules and facebow) ..Cat.No. NPH-003



Padded For Comfort
Fully Adjustable
Petit & Delaire

CHIN CAP



Cat.No. CHC-001

FACEBOW



Facebow Small... Cat.No. FBW-001
Facebow Medium... Cat.No. FBW-002
Facebow Large... Cat.No. FBW-003
Facebow activator tubes... Cat.No. FAT-001

SAFETY RELEASING MODULES



Safety Releasing Modules 1 pair..Cat.No.SRM-001



REVERSE PULL HEAD GEAR

Delaire multi adjustable...Cat.No. RPH-001
Petit multi adjustable..... Cat.No. RPH-002



Micro Screws Titanium
Self Drilling and Self Tapping

- 1.4 MM X 6 MM Cat.No. MS14-06
- 1.4 MM X 8 MM Cat.No. MS14-08
- 1.6 MM X 6 MMCat.No. MS16-06
- 1.6 MM X 8 MM Cat.No. MS16-08
- 1.6 MM X 10 MM Cat.No. MS16-10
- 2.0 MM X 8 MM Cat.No. MS20-08
- 2.0 MM X 10 MMCat.No. MS20-10

Screw Driver with hold..Cat.No. MS-SD1

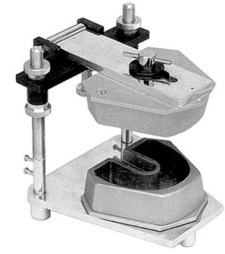

Typodont
Metal Cat.No. TPO-001
Plastic Cat.No. TPO-002

Photographic Mirrors
Stainless Steel Double Sided



- Set of four 1lingual, 1 buccal, 1 each adult and child occlusal..... Cat.No. PHM-001
Lingual..... Cat.No. PHM-002
Buccal..... Cat.No. PHM-003
Adult occlusal..... Cat.No. PHM-004
Child occlusal..... Cat.No. PHM-005



Base Former Rubber
Small.....Cat.No. RBF-001
Medium...Cat.No. RBF-002
Large.....Cat.No. RBF-003



- Acrylic Model with Ceramic Vs Metal Brackets**
Cat.No. PEM-001
Acrylic Model with Metal Brackets
Cat.No. PEM-002
Acrylic Model Plain No Brackets
Cat.No. PEM-003



Relief Wax
Cat.No. WAX-001



Teeth Metal.....TEH-001



Lip and Cheek Retractor
Medium ... Cat.No. RET-M08
Small Cat.No. RET-S07

Lab Wire

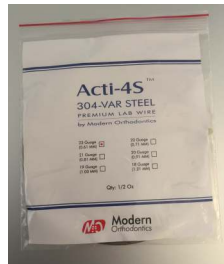

- 23 Gauge (0.61 MM) 10z/28Gm coil...LWC-23
- 22 Gauge (0.71 MM) 10z/28Gm coil...LWC-22
- 21 Gauge (0.81 MM) 10z/28Gm coil...LWC-21
- 20 Gauge (0.91 MM) 10z/28Gm coil...LWC-20
- 19 Gauge (1.00 MM) 10z/28Gm coil...LWC-19
- 18 Gauge (1.21 MM) 10z/28Gm coil...LWC-18

Lab Wire



- 23 Gauge (0.61 MM) 500 Gm Spool...LWS-23
- 22 Gauge (0.71 MM) 500 Gm Spool...LWS-22
- 21 Gauge (0.81 MM) 500 Gm Spool...LWS-21
- 20 Gauge (0.91 MM) 500 Gm Spool...LWS-20
- 19 Gauge (1.00 MM) 500 Gm Spool...LWS-19
- 18 Gauge (1.21 MM) 500 Gm Spool...LWS-18



Lip and Cheek Retractor with hold
Medium ... Cat.No. RET-M09
Large Cat.No. RET-L09



Cadmium Free Solder
.018" thick wire form
Silver Solder 5 DWT spool
Cat.No. SLS-5DWT



Archwire Organizer
Cat.No. ORG-001



Standard Expansion Screw
for removable appliance
Cat.No. SES-001



Hyrex RME Screw
Hyrex RME Screw 9mm... Cat.No. HES-001
Hyrex RME Screw 11mm... Cat.No. HES-002
Hyrex RME Screw 13mm... Cat.No. HES-003



Photographic Retractor
Medium...Cat.No. PHM-M05
SmallCat.No. PHM-S04



Flux
Flux 2 oz Jar..Cat.No. FLX-01



Sym Grid
Cat.No. OSG-001



Diamond Strips
Single sided..... Cat.No. DS-001
Double sided... Cat.No. DS-002

Perforated
Single sided.... Cat.No. DS-003
Double sided... Cat.No. DS-004

ACETM German Steel

Premium Instruments

by Modern Orthodontics

High Quality Surgical Grade German Steel

Designed for maximum comfort and safety

The quality of steel has a crucial effect on the quality of instruments.

German Steel is rust proof and provides durability and long lasting performance

New Pleasant glassy mat sand finish

All instruments are guaranteed against manufacturing defects

Proper handling and the correct use of cleaning solutions are the most important things to consider to ensure a long lifetime of the instrument



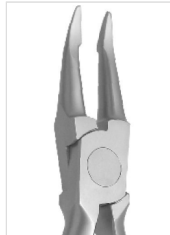
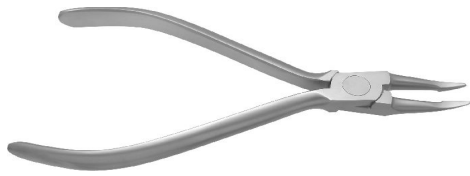

Weingart pliers slim
Cat.No. AC-101



Jaraback Pliers
Cat.No. AC-144



Weingart pliers universal
Cat.No. AC-102



Crown and Band
Contouring Pliers
Cat.No. AC-143



Posterior Band Remover
Cat.No.AC-130

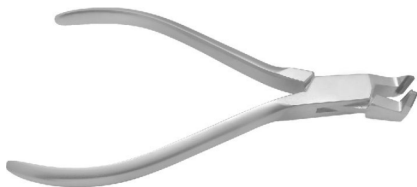

Distal end cutter long
with safety hold
Cat.No. AC-110



Lingual Weingart Plier fine
Long Handle 60° Angled
Cat.No. AC-103



Distal end cutter mini
with safety hold
Cat.No. AC-111



Omega Loop Forming
Tweed Style
Cat.No. AC-140



Distal end cutter
Safety Hold
Long Handle
Cat.No. AC-112



Distal end cutter
Flush cut, safety Hold
Long Handle
Cat.No. AC-113



How Pliers Curved
Cat.No. AC-142

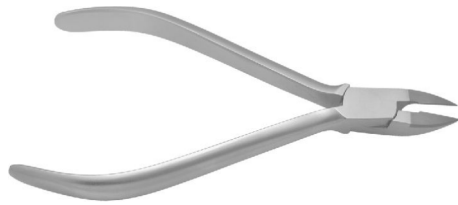
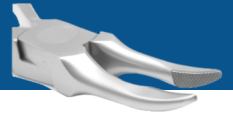

Pin & Ligature Cutter
TC
Cat.No. AC-120

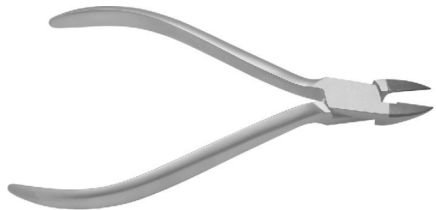

Pin & Ligature Cutter
Mini TC
Cat.No. AC-121

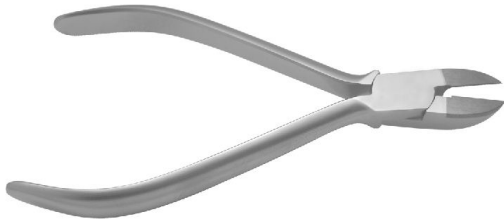

Hard Wire Cutter TC
Cat.No. AC-122



Tweed Arch Forming
(0.9 mm thick)
Cat.No. AC-135



Hook Crimping Plier
Cat.No. AC-136

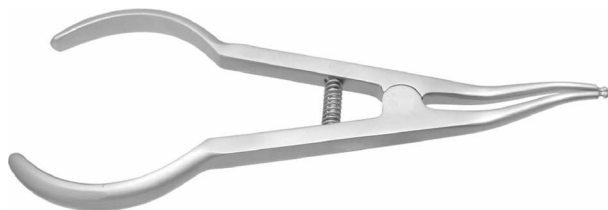

Separator Placing Plier
Cat.No. AC-137



Pin & Ligature Cutter
TC Angled 15°
Cat.No. AC-123



Reversed Ligature Cutter
Angled 40° With T.C
Cat. No. AC-124



Step Bending Plier
Cat.No. AC-138



Nance Loop Forming Plier
Cat.No. AC-139



How Pliers Straight
Cat.No. AC-141



Heavy Wire Cutter with sleeve
for extra oral use Cat.No. AC-242



Light Wire Bird
Beak Plier
Cat.No. AC-150



Light Wire Bird
Beak Long
Cat.No. AC-151



Bracket Remover Straight
Cat.No.AC-131



Bracket Remover Curved
Cat.No. AC-132

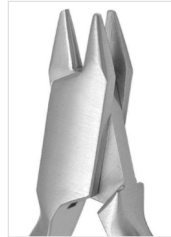

Three Prong Plier
Cat.No. AC-164



Hollow Chop
Contouring Plier
Cat.No. AC-165



De La Rosa Plier
With Grooves
Cat.No. AC-166



Adam Plier
Cat.No. AC-162



Young Universal Plier
with grooves
Cat.No. AC-163

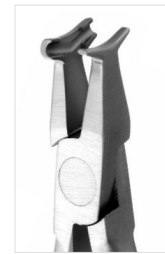

Hammer Head Plier
(For Distal Cinch Back)
Cat.No. AC-160



Stop "V" Bending Plier
Cat.No. AC-161
For "V" stop in SS wire



Heavy Duty Plier for TPA,
lingual arch and extraoral
appliances
Cat.No. AC-152

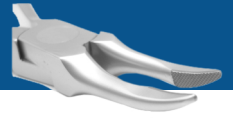

Ligature Forming Plier
Cat.No.AC-174



Mosquito Forceps Curved
Cat.No. AC-169

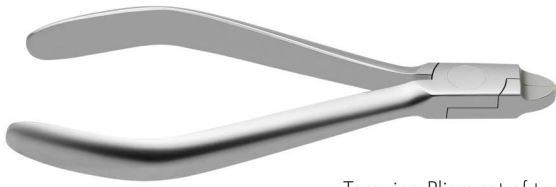

Torquing Pliers set of two
Cat.No.AC-172



Mosquito Forceps Straight
Cat.No. AC-167



Mathieu Needle Holder
Narrow Tip
Cat.No.AC-212



Torquing Plier with Key
Cat.No.AC-171



Band Pusher and scaler instrument
Cat.No.AC-200



Optical Pliers
Cat.No.AC-115



Double-Ended Distal End Bender
Cat.No.AC-203



Ligature director and tucker
Cat.No.AC-201



Dontrix Gauge for Tension and compression force measurement of upto 16 Oz Cat.No..... AC-254



Separating Strip Holder
Cat.No.AC-226

Ideal for cutting stainless steel



Turret 0 Deg Torque with 7 grooves from 0.016"-0.021" rectangular wires
Cat.No. AC-251

Band Cutting Scissors.
bands and ligatures.
Cat.No.AC-223



Boone Gauge Stainless Steel
Cat.No.AC-222

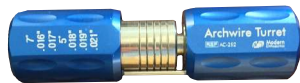

Turret 5 Deg & 7 deg Torque with 5 grooves. 7 deg for 0.016"-0.017" wires. 5 deg for 0.018", 0.019" & .021" rectangular wires
Cat.No. AC-252



Plier Stand SS Foldable
Cat.No.AC-243



Boone Gauge SS with Lead
Cat.No.AC-250



Impression Trays
Cat.No.AC-227



MBT Bracket Height Gauge Aluminum
for .018" slot.....Cat.No.AC-221
for .022" slot.....Cat.No.AC-220



MBT Bracket Height Gauge
Movable Head.....AC-225



Bracket Bonding Tweezer with Slot Positioner
Cat.No.AC-231



Bracket Bonding Tweezer Curved for Molar Tubes
Cat.No.AC-232

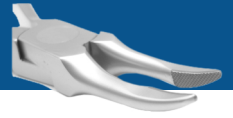

Bite Stick High Heat
Cat.No.AC-240



Moulded High Heat Plastic
With Stainless Tips

Safe For Dry Sterilization



Fine Serrated Tips for
Reduced Risk of Slippage



Mershon Band Pusher
Cat.No.AC-241

Lightweight Hollow handle



Boley Gauge Stainless Steel
Cat.No.AC-224



Bracket Positive Positioner
Cat.No.AC-230

Precise placement of direct bond tubes or attachments made simple with the spring-loaded mechanism and small, grooved tips. The Positive Positioner is made of lightweight, anodized aluminum.

Access first and second molars easily
Slides open smoothly to release tube





Modern
Orthodontics

2024 Gobind Nagar, Circuit House Road, Ludhiana - 141 001, Punjab (INDIA)
Email: modortho@gmail.com | contact@modernorthodontics.com
Web: www.modortho.com
Mobile: +91 77389 93291, +91 98140 32612